

Allway

Innovation Since 1935

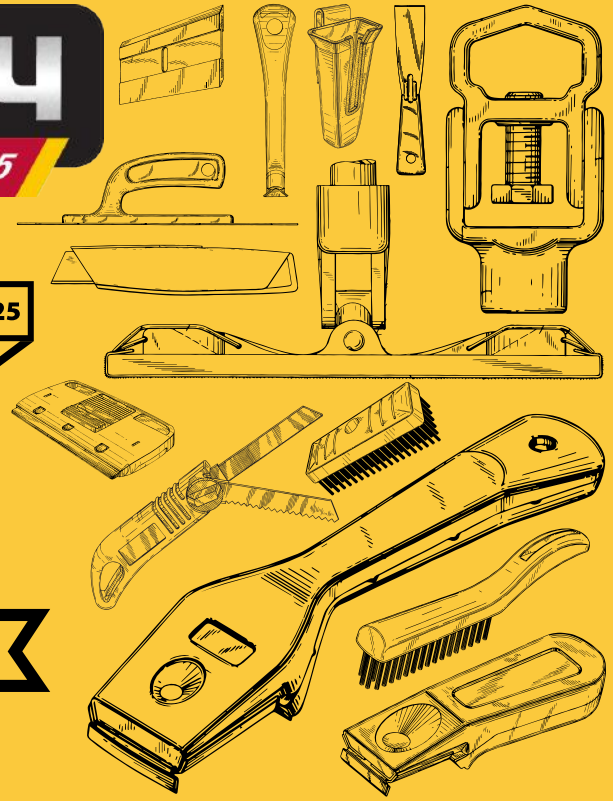
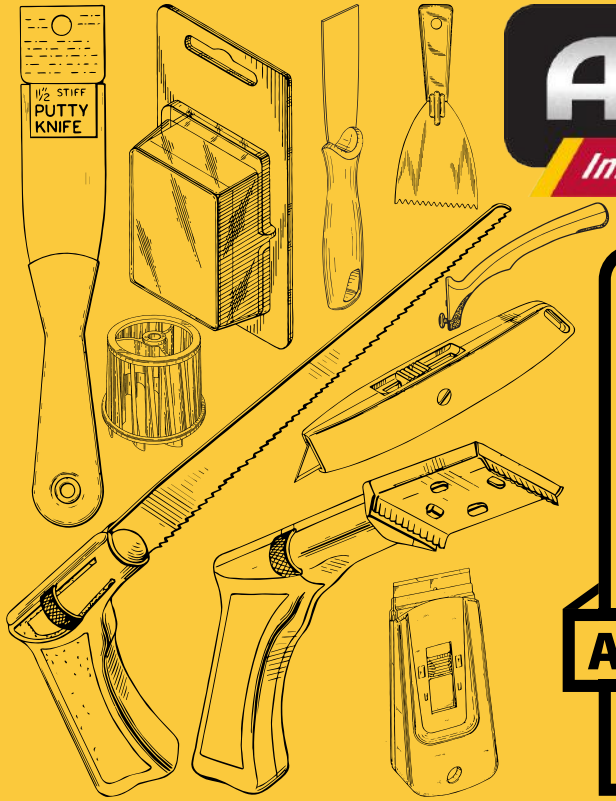

1935 - 2025

90TH

CATALOG

ANNIVERSARY

THE TOOLS YOU ASK FOR BY NAME

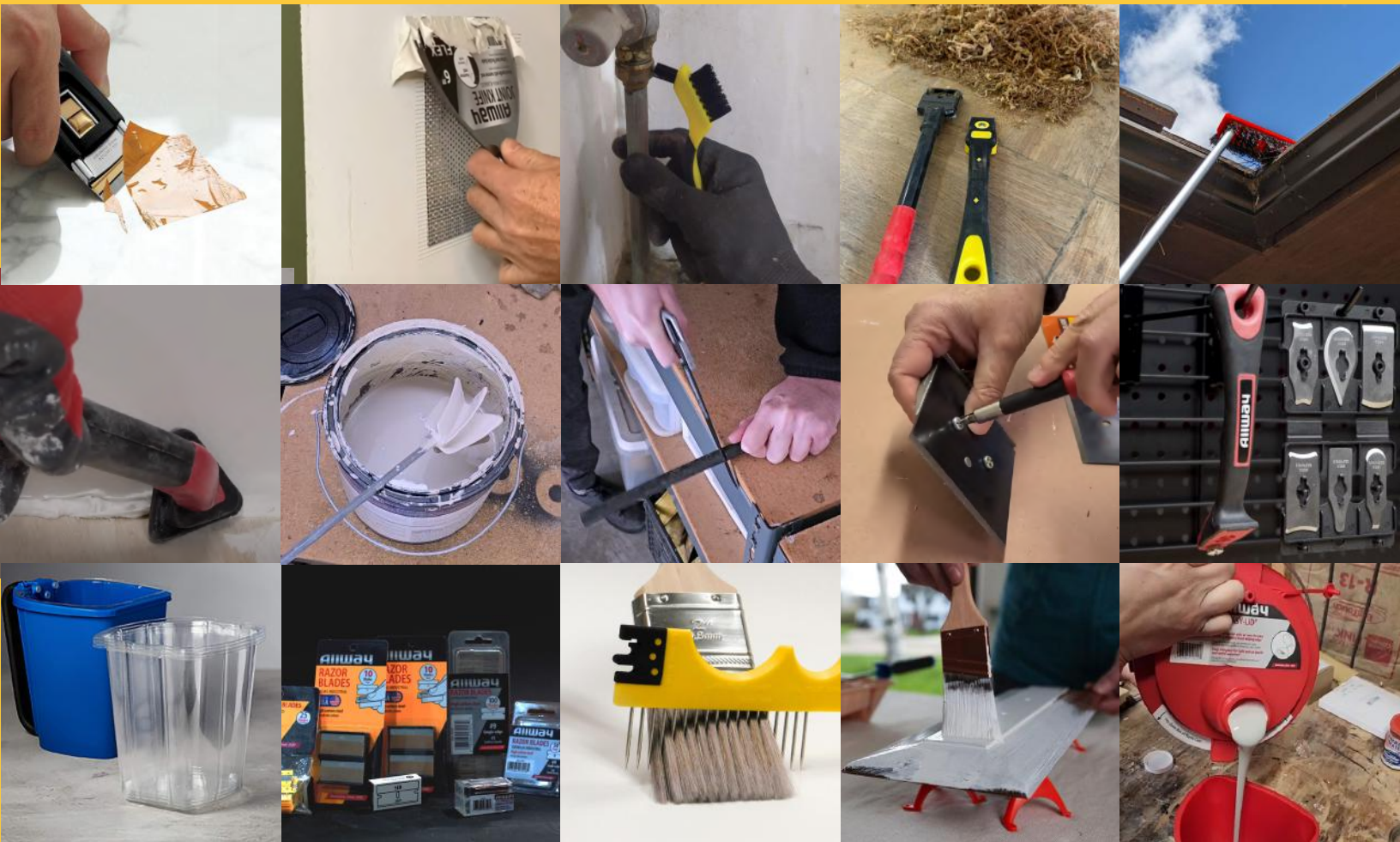

1255 Seabury Avenue, P.O. Box 777, Bronx, New York 10462 USA
Phone: 1-718-792-3636 · Toll-Free: 1-800-422-5592 · Fax: 1-718-823-9640
sales@allwaytools.com · cs@allwaytools.com · allwaytools.com

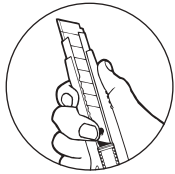

Knives & Blades

Utility & Safety Blades - 4
 Retractable Utility Knives - 5
 Fixed-Blade Utility Knives - 6
 Safety Knives - 7
 Snap-Off Knives - 8
 Snap-Off Blades - 9
 Linoleum Knives & Blades - 10
 Micro Knives & Blades - 10
 Knife Sheaths - 10
 Hobby Knives & Blades - 10



Scrapers & Blades

Single-Edge Razor Blades - 11
 Double-Edge Plastic Blades - 11
 Butterfly Scrapers - 12
 Mini Glass Scrapers - 12
 Butterfly Blades - 12
 Easy Cutters - 12
 Single-Edge Glass Scraper - 13
 Glass & Tile Scrapers - 13
 Euro-Style Scrapers - 13
 Wall Strippers - 14
 4" Universal Stripper Blades - 14
 Heavy-Duty Floor Scrapers - 15
 Professional Wood Scrapers & Blades - 16
 Soft-Grip Wood Scrapers & Blades - 17
 Contour Scraper & Blades - 18
 Carbide Wood Scrapers & Blades - 19
 Multi-Purpose Scrapers - 20



Putty & Joint Knives

Unibody Stainless-Steel (UX-Line) - 21
 Soft-Grip Stainless-Steel (SX-Line) - 21
 Soft-Grip Carbon-Steel (DSX-Line) - 22
 Ergonomic Nylon Handle (NX-Line) - 22
 Vintage Nylon Handle (X-Line) - 23
 All-Stainless Steel (T-Line) - 23
 Economy Plastic Handle (PT-Line) - 24
 Celcon (POM) & Polypro (PP) - 24
 Promotional (SG-Line) - 24



Taping Knives

Premium Stainless Steel (UTK-Line) - 25
 Soft-Grip Stainless Steel (STKB-Line) - 25
 Soft-Grip Blue Steel (BTK-Line) - 26
 Textured-Grip Blue Steel (TK-Line) - 26



Drywall Tools

Drywall Mud Pans - 27
 Drywall Taper Banjo - 28
 Hand & Pole Sanders - 29
 Wall-EZ™ Drywall Repair System - 30
 Drywall Repair Patches - 31
 Wall Shields - 31
 Corner Tools - 32
 Drywall Hawks - 32
 Drywall Rasp - 33
 Small Hole Filler Repair Kits - 33
 Drywall Jab Saws - 33



Saws & Screwdrivers

Handy Saw - 34
 5-in-1 Safety Screwdriver - 35



Paint Accessories

Helix Mixers - 36
 Paint Pails, Cups & Liners - 37
 Paint Mesh Strainers - 37
 Wet Brush & Roller Protectors - 38
 Plastic Pail Openers - 39
 Can & Bucket Openers - 39
 Paint & Trim Shields - 40
 Aluminum Paint Spray Shield - 40
 Sanding Sponges - 41
 Paint Pouring Spouts - 41
 Painter's Tripods - 42
 Wood Graining Tools - 42
 Telescopic Paint Bucket System - 43
 Painter's Multi-Tools - 44
 Miscellaneous - 44 - 46

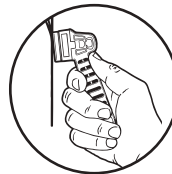

Wallcovering, Flooring & Masonry

Soft-Grip Trowels & Floats - 47
 Wallcovering Tools - 48

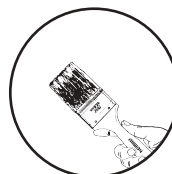

Brushes

Masonry Brushes - 49
 Wallpaper Brushes & Smoothers - 49
 Glue Brushes - 49
 Scrub Brushes - 50
 Gutter Guard Brush - 51
 Stripping Brush Set - 51
 Soft-Grip Mini Brushes - 52
 Soft-Grip Small Brushes - 53
 Soft-Grip Large Wire Brushes - 54
 Wood-Handle Wire & Welding - 55
 Master-Pro Paint Brushes - 56

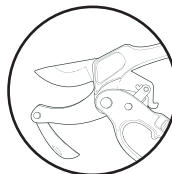

Garden Tools

Pruners, Snips & Shears - 57

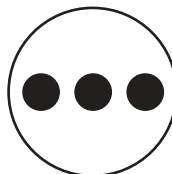

Et Al.

Table of Contents - 2
 Company History - 3
 Merchandisers & Display - 58 - 62
 Bucket Program - 63
 Terms & Conditions - 64
 Become an ALLWAY Partner - 65

1935 COMPANY FOUNDING

From the family hardware store, founder Louis Gringer manufactured and sold the original All-Way Handy Saw. Its success was so transformative that the company, originally Ultra Manufacturing Company, rebranded itself as Allway Tools.



1954-1964 SON JOINS COMPANY

After graduating with a degree in industrial engineering, Donald Gringer joins the company as an engineer. His first projects would involve the redesign of the Handy Saws and introducing the first generation of Allway wood scrapers, still available to this day.



1982-1986 ERGONOMIC DESIGN

To adapt to evolving market demands, Allway Tools redesigned industry staples, including adding a soft-grip handle to the wood scrapers, improving the blade-retaining tool head for wall strippers, and introducing the all-metal Safety Glass Scraper.



1991 CURRENT LOCATION

From the mid-1950s to the 1990s, Parkchester served as Allway Tools' headquarters. To meet increasing demand from big-box retailers and international distributors, the company relocated to its current location in Unionport.



1997 5-IN-1 SCREWDRIVER

This screwdriver's lightweight, durable design makes it easy to handle while maintaining strength for tough tasks. Its slim profile allows access to tight spaces where traditional screwdrivers struggle, reducing the need to carry multiple tools at once.

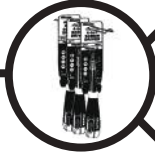

2000 WIRE BRUSHES

Allway's wire brushes excel in design and durability, featuring a soft-grip handle with finger grooves for added control and reduced hand fatigue. The offset, curved design also provides hand protection during extended use.



2001 LEADERSHIP IN SAFETY

Allway's expertise in safety knife solutions has positioned the brand as a strategic partner for risk mitigation among leading Fortune 500 companies. These organizations have optimized safety protocols, reducing workplace incidents and liability.



2017 ALLWAY JOINS LINZER

Through this exciting new chapter, the enduring principles established by the Gringer family remain at the heart of Allway's mission: a commitment to quality, innovation, and design. Today, we still are the tools you trust and ask for by name.



UTILITY & SAFETY BLADES

- High-carbon steel for strength and durability
- Industrial-grade hardness and wear resistance
- Ideal for quick, shallow cuts
- Compatible with most standard utility knives
- Suitable for professionals & DIYers
- Available in blackened carbon steel for additional sharpness & titanium for durability
- Safety blades have round points that help reduce the incidence and severity of injuries



Learn more about our Utility & Safety Blades

ACCEPTS USED BLADES FOR SAFE DISPOSAL



DSP100 (07019) 3-NOTCH UTILITY BLADES, 100-PACK DISPENSER

DSP50 (07112) 3-NOTCH UTILITY BLADES, 50-PACK DISPENSER

The blades come in a tough, clear plastic dispenser—stronger than the brittle black ones out there. It also has a safe slot for easy blade disposal.



KBS5 (07101) 3-NOTCH ROUNDED-POINT SAFETY BLADES, 5-PACK

KBS100 (07107) 3-NOTCH ROUNDED-POINT SAFETY BLADES, 100-PACK

The blades feature rounded points that reduce the chance of puncture injuries or unwanted damage to box contents.



RKB5 (07010) 3-NOTCH UTILITY BLADES, 5-PACK

RKB10 (07033) 3-NOTCH UTILITY BLADES, 10-PACK

The safe sliding dispenser which ensures safe access to the blades & avoid injury.

RKB100 (07009) 3-NOTCH UTILITY BLADES, 100-PACK

Designed to cut thick, dense sheet material, drywall, carpet, wallpaper, shingles & a variety of other materials.



BKB5 (41065) 2-NOTCH BLACKENED STEEL UTILITY BLADES, 5-PACK

Heat-treated blades are ultra-sharp compared to standard high-carbon steel.



TKB5 (41064) 2-NOTCH TITANIUM-COATED UTILITY BLADES, 5-PACK

Titanium coating boosts durability and resists corrosion better than standard high-carbon steel blades.



SKB5 (41066) 2-NOTCH SERRATED UTILITY BLADES, 5-PACK

Multiple cutting edges that distribute friction evenly, allowing faster, smoother cuts.



KB92-5 (07119) 2-NOTCH UTILITY BLADES, 5-PACK

KB10 (07121) 2-NOTCH UTILITY BLADES, 10-PACK

KB92 (07108) 2-NOTCH UTILITY BLADES, 100-PACK

Ideal for cutting drywall, roofing materials, linoleum, carpet, vinyl, rope, paper, opening boxes, trimming wallpaper and much more.



PRK (07103) PLASTIC RETRACTABLE UTILITY KNIFE, 1 BLADE

Made with a tough ABS plastic casing and a lightweight engineering-grade plastic body for durability and ease of use.



RK4 (07005) RETRACTABLE UTILITY KNIFE, 3 BLADES

Features a self-lubricating Delrin slider for smooth, easy cutting; three cutting positions.



SLK (07990) RETRACTABLE UTILITY KNIFE, 3 BLADES

Features a heavy duty all-metal construction for longevity; three cutting positions.



RSK (07207) SOFT-GRIP RETRACTABLE UTILITY KNIFE, 3 BLADES

Features an elongated ergonomic design, providing added comfort during prolonged use; exclusive rubber fingers inside prevent stored blades from dulling.



HRK2 (41049) HEAVY-DUTY UTILITY KNIFE, 3 BLADES

Integrated film cutter enhances efficiency; ergonomic textured grip provides comfort.



SWK (12817) SWITCHBACK SAFETY KNIFE

Unique patented design that combines the best of a lock-back knife and switchblade.

SWK-DSP (19213) 14-PIECE COUNTER DISPLAY

RETRACTABLE UTILITY KNIVES

- Ideal for everyday use
- Made from durable plastic or metal
- Adjustable blade for precise cutting
- Blade fully retracts for safety when not in use
- Safer than fixed-blade knives
- For both professionals and DIYers



Learn more about our Retractable Utility Knives

SAFER THAN FIXED BLADE KNIVES



PRK25 (07100) PLASTIC RETRACTABLE UTILITY KNIFE, 25 PER BUCKET

Made with a tough ABS plastic casing and a lightweight engineering-grade plastic body for durability and ease of use.



SLK25 (07110) RETRACTABLE UTILITY KNIFE, 25 PER BUCKET

Features a heavy duty all-metal construction for longevity; three cutting positions.

FIXED-BLADE UTILITY KNIVES

- Ideal for tough tasks requiring force & control
- Perfect for cutting through thick materials
- Provides consistent cutting depth
- Durable & wear-resistant
- Allows for one-handed access & accurate cuts
- For professionals needing heavy-duty tools



Learn more about our Fixed-Blade Utility Knives

ALWAYS READY TO USE— NO NEED TO EXTEND OR ADJUST



KC25 (07001) POLY-PRO PLASTIC UTILITY KNIVES, 25 PER BUCKET
Each knife includes one blade, making it a cost-effective choice for both professionals and DIY enthusiasts; tool-free blade change.

CONTOURED TO FIT COMFORTABLY IN
THE PALM OF YOUR HAND



KF3 (07028) FIXED-BLADE UTILITY KNIFE, 3 BLADES
This knife is built to withstand the toughest conditions.

EXCLUSIVE RUBBER FINGERS INSIDE
PREVENT DULLING OF STORED BLADES



DWK (07206) SOFT-GRIP FIXED-BLADE UTILITY KNIFE, 3 BLADES
This knife is designed for long-lasting use in various cutting applications.

**COMBINES STRENGTH OF A FIXED BLADE WITH
THE CONVENIENCE OF A POCKET KNIFE**



FKP (41107) FOLDING LOCK-BACK KNIFE, 1 BLADE
LDK3 (00000) LIGHT-DUTY KNIFE, 3-PACK
Press front button for quick-release blade change.

BUILT-IN STORAGE UNIT
HOLDS 3 EXTRA BLADES



FK3B (41047) SOFT-GRIP FOLDING UTILITY KNIFE, 3 BLADES
With extra blade storage and robust aluminum alloy construction, this folding knife is an essential companion for professionals and DIY enthusiasts.



SRK-B6 (07202) ALUMINUM SAFETY KNIFE, 6 BLADES

SRK (41037) ALUMINUM SAFETY KNIFE, 1 BLADE

Built to withstand heavy-duty use in various commercial settings.

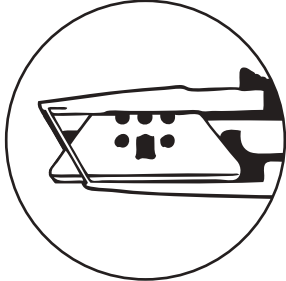

Rounded Point

Helps reduce the chance of puncture injuries.



Deeper Cutting

Remove blade, lift slider & snap off the tab.



ARK (07102) SELF-RETRACTING SAFETY KNIFE, 1 BLADE

ARK-B7 (07707) SELF-RETRACTING SAFETY KNIFE, 6 BLADE

For both left & right-hand operation, with the option for short or long blade exposure.

Foldable Thumb Guides

Quickly remove carton tops to access the contents inside.

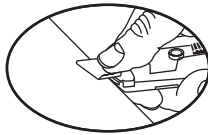

RTC (07204) RETRACTABLE CARTON CUTTER, LEFT & RIGHT THUMB GUARD

Can be used as a standard utility knife when the thumb guides are folded back or as a box top cutter when either the left or right thumb guide is folded forward.



SSK (07995) METAL SELF-RETRACTING SAFETY KNIFE, 3 BLADES

Switch effortlessly between short & long blade exposure adapts to your specific cutting needs.



ARKV-B3 (41029) PLASTIC VANISHING SAFETY KNIFE, 3 BLADES

Blade automatically retracts after cut even if still engaged.

SAFETY KNIVES

- Primarily for opening boxes & packaging
- Maximizes safety & minimizes danger
- Easy to use with either hand, suitable for everyone
- Most models include “EZ push button” for quick, tool-free blade changes
- Uses round-point safety blades

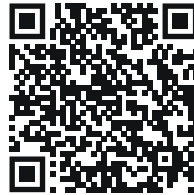

Learn more about our Safety Knives



BSRK-B6 (12821) PELICAN DUAL-FUNCTION SAFETY KNIFE, 6 BLADES

Cuts through cartons, pallet wrap, heavy-duty plastic banding, and zip ties with ease.



SHK (07203) SAFETY HOOK KNIFE, FOR FILM & STRAPPING

Opens shrink wrapped pallets and plastic strapping with ease.



FSK (12818) DOUBLE-HOOK FILM CUTTER

Features a double sided design with two concealed blades; honed to slice through packaging materials from zip ties to film & shrink wrap.

SNAP-OFF KNIVES



RK7 (07054) 18MM SOFT-GRIP SNAP-OFF KNIFE, 3 BLADES
Integrated blade snapper to help snap dull points off for a fresh cutting edge.

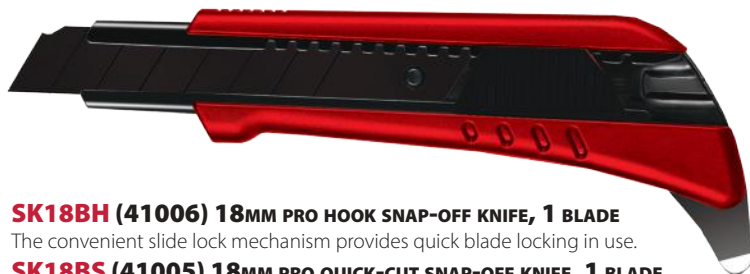

SK18BH (41006) 18MM PRO HOOK SNAP-OFF KNIFE, 1 BLADE

The convenient slide lock mechanism provides quick blade locking in use.

SK18BS (41005) 18MM PRO QUICK-CUT SNAP-OFF KNIFE, 1 BLADE

Convenient slide lock mechanism provides quick and reliable blade auto-locking for enhanced safety during use

SK18BW (41004) 18MM PRO SOFT-GRIP SNAP-OFF KNIFE, 1 BLADE

Ratchet-wheel lock provides a positive lock for additional security.



SK18T (41007) 18MM PREMIUM SOFT-GRIP SNAP-OFF KNIFE, 1 BLADE

Safety lock feature adds an extra layer of protection, keeping the blade in place.



SK25B (41010) 25MM HEAVY-DUTY PRO SNAP-OFF KNIFE, 1 BLADE

Ratchet-wheel lock provides a positive lock for additional security.



SK25BD (41009) 25MM SOFT-GRIP SNAP-OFF KNIFE, 1 BLADE

Ratchet-wheel lock provides a positive lock for additional security.



SK25T (41008) 25MM PREMIUM SNAP-OFF KNIFE, 1 BLADE

Ratchet-wheel lock provides a positive lock for additional security.



K130 (07060) 9MM SNAP-OFF KNIFE, 1 BLADE

K13-50 (07040) 9MM SNAP-OFF KNIFE, 1 BLADE, 50 PER BUCKET

Made of durable ABS plastic for durability on any cutting job.



KS13 (07750) 9MM DELUXE SNAP-OFF KNIFE, 3 BLADES

Robust stainless steel track enhances stability and durability for smooth cutting.



RK13 (07042) 9MM SOFT-GRIP SNAP-OFF KNIFE, 3 BLADES

Crafted with a durable aluminum body, this knife is built to withstand heavy-duty use.

RK13A (07043) 9MM AUTO-LOAD SNAP-OFF KNIFE, 3 BLADES

Auto-locking mechanism ensures secure positioning upon extension.



SK9M (41001) 9MM METAL SNAP-OFF KNIFE, 1 BLADE

Self-locking mechanism adds an extra layer of protection, keeping the blade in place.



SK9B (41002) 9MM PRO SOFT-GRIP SNAP-OFF KNIFE, 1 BLADE

Auto-lock feature ensures blade stability and safety during use.



SK9T (41003) 9MM PREMIUM SOFT-GRIP SNAP-OFF KNIFE, 1 BLADE

Safety lock feature adds an extra layer of protection, keeping the blade in place.



K700 (07070) 18MM SNAP-OFF KNIFE, 1 BLADE

K7-25 (07050) 18MM SNAP-OFF KNIFE, 1 BLADE, 25 PER BUCKET

Made of durable ABS plastic for durability on any cutting job.

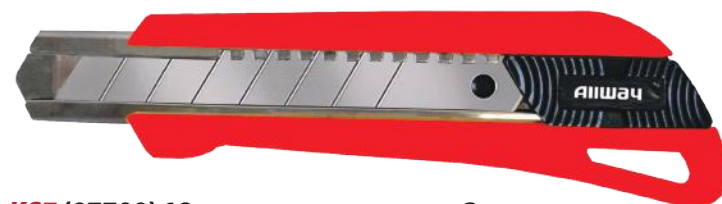

KS7 (07700) 18MM DELUXE SNAP-OFF KNIFE, 3 BLADES

Robust stainless steel track enhances stability and durability for smooth cutting.

SNB (07027) 9MM CARBON-STEEL SNAP-OFF BLADES, 5-PACK

SNB100 (07055) 9MM CARBON-STEEL SNAP-OFF BLADES, 100-PACK

These carbon-steel blades feature 13 blade sections for extended use.

SNB/SS (07057) 9MM STAINLESS-STEEL SNAP-OFF BLADES, 5-PACK

These stainless-steel blades feature 13 blade sections for extended use.



SB9-5C (41011) 9MM CARBON-STEEL SNAP-OFF BLADES, 5-PACK

SB9-20C (41012) 9MM CARBON-STEEL SNAP-OFF BLADES, 20-PACK

These high carbon-steel blades feature 13 blade sections for extended use.

SB9-5B (41013) 9MM BLACKENED-STEEL SNAP-OFF BLADES, 5-PACK

SB9-20B (41014) 9MM BLACKENED-STEEL SNAP-OFF BLADES, 20-PACK

These blackened high carbon-steel blades feature 13 blade sections for extended use.

SB9-5T (41015) 9MM TITANIUM SNAP-OFF BLADES, 5-PACK

These titanium-coated high carbon-steel blades feature 13 blade sections for extended use.

K7B (07051) 18MM CARBON-STEEL SNAP-OFF BLADES, 5-PACK

K7B100 (07065) 18MM CARBON-STEEL SNAP-OFF BLADES, 100-PACK

These carbon-steel blades feature 8 blade sections for extended use.

K7B/SS (07052) 18MM STAINLESS-STEEL SNAP-OFF BLADES, 5-PACK

These stainless-steel blades feature 8 blade sections for extended use.



SB18-5C (41016) 18MM CARBON-STEEL SNAP-OFF BLADES, 5-PACK

SB18-20C (41017) 18MM CARBON-STEEL SNAP-OFF BLADES, 20-PACK

These high carbon-steel blades feature 8 blade sections for extended use.

SB18-5B (41018) 18MM BLACKENED-STEEL SNAP-OFF BLADES, 5-PACK

SB18-20B (41019) 18MM BLACKENED-STEEL SNAP-OFF BLADES, 20-PACK

These blackened high carbon-steel blades feature 8 blade sections for extended use.

SB18-5T (41020) 18MM TITANIUM SNAP-OFF BLADES, 5-PACK

These titanium-coated high carbon-steel blades feature 8 blade sections for extended use.

SNAP-OFF BLADES

- Snap-off blades provide fresh cutting points with every section you snap off
- Premium blades offer heavy-duty, industrial-quality performance
- Great hardness and wear resistance
- Available in 9mm, 18mm, and 25mm sizes.
- Perfect for both professionals & DIYers
- Snap-off sections for blades last longer
- Safe disposal for added peace of mind

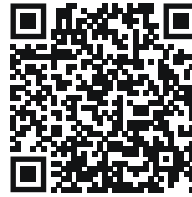

Learn more about our 9mm, 18mm & 25mm Snap-Off Blades



SB25-5B (41021) 25MM BLACKENED-STEEL SNAP-OFF BLADES, 5-PACK

SB25-20B (41022) 25MM CARBON-STEEL SNAP-OFF BLADES, 20-PACK

These blackened high carbon-steel blades feature 7 blade sections for extended use.

SB25-5T (41023) 25MM TITANIUM SNAP-OFF BLADES, 5-PACK

These titanium-coated high carbon-steel blades feature 8 blade sections for extended use.

LINOLEUM KNIVES & BLADES

- Designed for cutting and trimming linoleum, tile, carpet, drywall, vinyl, cartons, rope & more



LK30 (07208) SOFT-GRIP LINOLEUM KNIFE

Feather-soft santoprene handle.

LK25 (07008) HEAVY-DUTY HARDWOOD LINOLEUM KNIFE

Heavy-duty hardwood handle.



LKB5 (07011) 3-NOTCH LINOLEUM HOOK BLADES, 5-PACK

Swivel belt mount allows wear while sitting, bending etc. without discomfort.

LKB100 (07012) 3-NOTCH LINOLEUM HOOK BLADES, 100-PACK

LRB (07026) 2-NOTCH LINOLEUM HOOK BLADE

Cuts and trims roofing materials, linoleum, carpet, fabric, cartons, and sheet metal; compatible with fixed-blade knives only.

KNIFE SHEATHS

- Protects your knife.
- Plastic sheaths resist moisture, and nylon sheaths resist wear.
- Lightweight, flexible & easy to carry.
- Knife sheaths allow quick access & prevent cuts.



PKS (07071) PLASTIC KNIFE SHEATH

Swivel belt mount allows wear while sitting, bending etc. without discomfort.

LKS (07072) LEATHER KNIFE SHEATH

Durable leather knife sheath attaches with a belt loop for securely carrying knife.

NKS (07073) NYLON KNIFE SHEATH

Durable ballistic nylon holds utility knives and pliers securely on tool belt.

MICRO KNIVES & BLADES

- Ideal for opening boxes, cutting string, and slicing through cardboard, rope, and canvas
- Sharp point and straight edge for precise cuts
- For easy carrying in a pocket or purse
- Convenient and efficient for on-the-go use



MKB5 (07104) MICRO UTILITY BLADES, 5-PACK

MK4 (07006) CHROMED DIE-CAST MICRO KNIFE, 1 BLADE

MK3-50 (07020) NEON LEXAN MICRO KNIVES, 50 PER BUCKET

Ideal for cutting corrugated cardboard, paper, wallcovering, carpet, and more.



HOBBY KNIVES & BLADES

- Hobby knives are ideal for detailed cuts.
- Suitable for both professionals and hobbyists.
- Sharp #11 blades for precise cuts.
- Can cut materials like paper, plastic, and wood.



HB11 (07211) #11 HOBBY REPLACEMENT BLADES, 5-PACK

Compatible with the HK1 and other similar hobby knives in the market.



HK1 (07212) #1 HOBBY KNIFE

Grooved-grip surface on the handle reduces fatigue and offers precision & control.



SEB10 (07015) SINGLE-EDGE RAZOR BLADES, 10-PACK

Designed to fit most standard single edge scrapers, box cutters, and similar tools, these blades tackle label removal, adhesive cleaning, package opening, and more.

SEB100/5 (07090) 5-PACK BLADE DISPENSERS, 50 PER BUCKET

50 5-pack sleeves of 1095C single edge razor blades per bucket.

SEB10-50 (07095) 10-PACK BLADE DISPENSERS, 50 PER BUCKET

50 10-pack patented dispensers of 1095C single edge razor blades per bucket.



SEB100AD (07217) SINGLE-EDGE RAZOR BLADES, DISPENSER, 100-PACK

The patented dispenser holds the blades securely, so they won't fall out in a toolbox or when dropped. Dispose used blades in the built-in compartment.

SINGLE-EDGE RAZOR BLADES

- High-carbon steel for durability
- Available in 0.009" and 0.012" thickness
- Plated steel, full-depth backing
- Fits most standard scrapers
- For removing labels, adhesive, paint & more
- Strong and reliable for various tasks
- Includes a dispenser for safe and easy storage

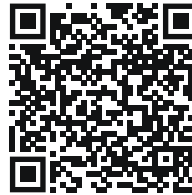

Learn more about our Single-Edge Razor Blades

DOUBLE-EDGE PLASTIC BLADES

- Safely scrape off adhesive, paint, and other gunk without scratching surfaces
- Two plastic edges prevent marks, ideal for delicate jobs
- Fits most standard scrapers

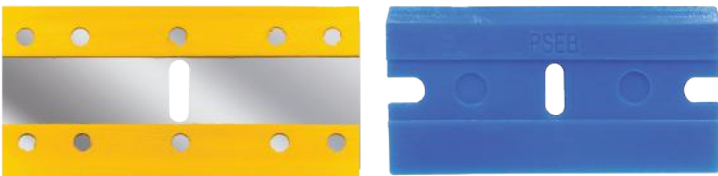

PSEB (07117) STEEL-CORE PLASTIC RAZOR BLADES, 25-PACK

Celcon, double-edge blade for scraping adhesive, residue, gum, paint - reduces the chance of scratching delicate surfaces.

PSEB-P (07118) ALL-PLASTIC RAZOR BLADES, 25-PACK

Same as the above but no steel, all-plastic.



SEB50 (07018) #9 SINGLE-EDGE RAZOR BLADES, 50-PACK

Clamshell containing 50 1095C single-edge razor blades.

SEB100VP (17017) #9 SINGLE-EDGE RAZOR BLADES, 100-PACK

Clamshell containing 100 1095C single edge razor blades.

SEB112VP (41094) #12 SINGLE-EDGE RAZOR BLADES, 100-PACK

0.012" thick, industrial quality blades that have zinc-plated steel backing.

SEB112 (07092) #12 SINGLE-EDGE RAZOR BLADES, 100-PACK BOX

0.012" thick, industrial quality blades that have zinc-plated steel backing.



BUTTERFLY SCRAPERS

- Tough and durable for various scraping jobs
- Sharp edges for scraping glass and tile
- Duller side for tougher surfaces like metal
- More than twice as thick as a regular razor blade for added strength and longevity



LUS (07152) LONG-HANDLE UTILITY SCRAPER, 3 BLADES
Can be used to scrape glass, tile and other delicate surfaces.

GUS (07150) HEAVY-DUTY UTILITY SCRAPER, 1 BLADE
Open/close with patented, easy push button lock.

BUTTERFLY BLADES

- Sharp edge for scraping glass and tile
- Blunted edge for scraping metal
- Heavy-duty 0.0024" thickness
- Twice as thick as single-edge razor blades

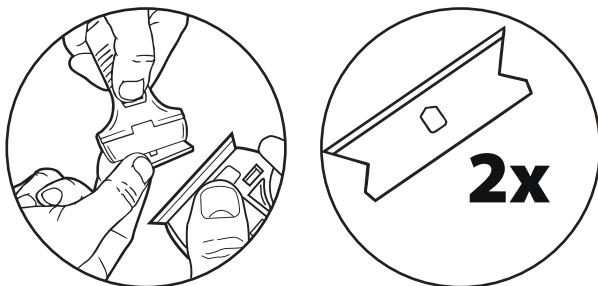

Compatible
Can be used with the Allway GUS & LUS scrapers.

Heavy-Duty
Two times thicker than a single-edge razor blade.



BFL (07151) BUTTERFLY SCRAPER BLADES, 5-PACK
Blunt end for scraping metal; sharp end for scraping glass & tile.

MINI GLASS SCRAPERS

- Cuts corrugated cardboard, paper, wallcovering, and other materials
- Makes small tasks effortless



GSM (07089) MINI GLASS SCRAPER, 1 BLADE

GSM5 (07190) MINI GLASS SCRAPER, 5 BLADES

GSMP5 (07191) MINI GLASS SCRAPER, 5 STEEL-CORE BLADES

GSM100 (07080) MINI GLASS SCRAPER, BUCKET OF 100



EASY CUTTERS

- Functions as both a knife & a scraper
- Ideal for removing stickers, paint residue & more from windows, tiles, boxes, concrete, and walls



EK (07030) NEON EASY CUTTER

EK50 (07035) NEON EASY CUTTER, 50 PER BUCKET



GS (07007) SAFETY GLASS SCRAPER, 5 BLADES

GS1 (07088) SAFETY GLASS SCRAPER, 1 BLADE

Heavy-duty, all-steel retractable blade scraper that can be used to scrape paint from glass, tile, metal, and other hard, flat surfaces.

GS50 (07088) SAFETY GLASS SCRAPERS, 50 PER BUCKET

50 retractable glass scrapers per bucket.

SGS (07307) SOFT-GRIP GLASS SCRAPER, 5 BLADES

All-steel, safety glass scraper with our patented rubber boot for comfortable scraping.

SGS25 (07327) SOFT-GRIP GLASS SCRAPERS, 25 PER BUCKET

25 soft-grip retractable glass scraper per bucket.



LGS (41097) COLLAPSIBLE LONG-HANDLE SCRAPER, 1 BLADE

Removes paints, adhesive & grime; adjustable from 8.75" to 13.5"

SINGLE-EDGE GLASS SCRAPERS

- Ideal for removing paint from glass, tile, metal, and other hard surfaces
- Includes five heavy-duty razor blades in a special safety dispenser
- Rust-resistant finish for durability
- Bronze cover for smooth operation
- Built-in safety lock keeps the blade secure during use
- High-carbon steel blades for tough, long-lasting performance



Learn more about our Single-Edge Glass Scrapers

GLASS & TILE SCRAPERS

- Removes paint from glass, tile, metal, and floors
- EZ push button for quick blade changes
- Uses a 4" universal blade (WSB)
- Soft, dual-molded grip for added comfort



GTS (07400) 4" SOFT-GRIP GLASS & TILE SCRAPER, 1 BLADE

Scrapes paint off glass, tile, metal and floors.

GTS-G (07401) 4" SOFT-GRIP GLASS & TILE SCRAPER, GUARD, 1 BLADE

Same as above but with a snap-on blade guard for additional user safety.

GSK3 (07470) 12-PIECE GLASS & TILE SCRAPER KIT

For a variety of scraping purposes on glass, tile, metal, flooring and other flat surfaces.

GSK3-DSP (19210) 12-PIECE COUNTER DISPLAY

Counter display includes 11 glass & tile scraper kits.

EURO-STYLE SCRAPERS

- For window cleaners, contractors, and DIYers
- Removes paint, tape, stickers, caulk, and more
- Works on windows, glass, tiles & more
- Comfortable grip for side-to-side scraping



GRS (07045) 4" WIDE EURO-STYLE GLASS & TILE SCRAPER, 1 BLADE

Removes tough spots and grime on a variety of surfaces, including home windows and doors, car windows and windshields, mirrors, glass, and tile floors.

WALL STRIPPERS

- Removes wallpaper, vinyl, wall cloth, and tile
- Great for cleaning floors, glass, and tile
- Sharp 4" blade for scraping and a dull edge for safe storage
- Ideal for all kinds of prep work
- Patented design allows quick blade swaps—just twist the handle, no tools needed



Learn more about our Wall Strippers

4" UNIVERSAL STRIPPER BLADES

- Tough, heavy-duty 4" blades for wall strippers, glass, and tile scrapers
- 0.014" thick for durability and strength
- Can be snapped down to 3.5" for compatibility with other tools
- Blunt edge with rounded corners for safety
- Built for all kinds of stripping jobs



WSB (07025) 4" UNIVERSAL STRIPPER BLADES, 5-PACK
Can be used with all standard 4" scrapers and wallpaper strippers



WSB10 (07034) 4" UNIVERSAL STRIPPER BLADES, 10-PACK
Easy-to-use convenient dispenser includes ten 4" replacement blades.

WSB100 (07075) 4" UNIVERSAL STRIPPER BLADES, 100-PACK BOX
Two 50-pack dispensers include one hundred 4" replacement blades.



Easy Blade Change

No need for a screwdriver. Make a quarter turn to unlock.



Versatile

Ideal for removing wallpaper & cleaning hard surfaces

- WPS (07200) 12" ALUMINUM-HEADED WALL STRIPPER**
12" patented, soft-grip handle allows you to scrub various surfaces with ease.
- WPSZ (07255) 12" ZINC-HEADED WALL STRIPPER**
12" tubular handle allows you to scrub various hard surfaces.
- WPSZ-L-CD (81690) 21" ZINC-HEADED WALL STRIPPER**
21" tubular handle allows you to scrub various hard surfaces.

SNAP-ON GUARDS ADD USER SAFETY



ZINC HEAD

ALUMINUM HEAD

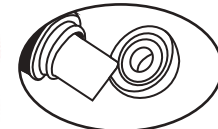

Blade Storage

Spare blades can be stored inside WPS handle.

NOW WITH HAMMER END



FS18 (07220) 18" HEAVY-DUTY FLOOR SCRAPER, HAMMER END
18" handle and soft-grip for added comfort during extended and heavy use.

FS48 (07221) 48" HEAVY-DUTY FLOOR SCRAPER
18" handle and soft-grip for added comfort during extended and heavy use.

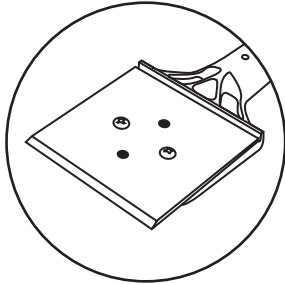

Fixed Molded Pins

Shares the blunt chopping force & protects screws that hold blade in place.

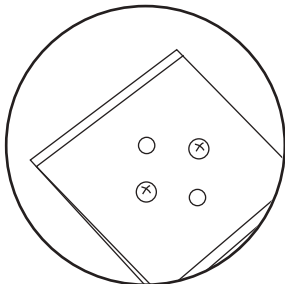

Blunt Edges

Remove materials from walls, floors, roofing & other surfaces

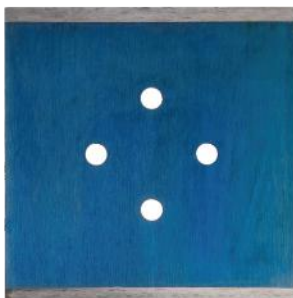
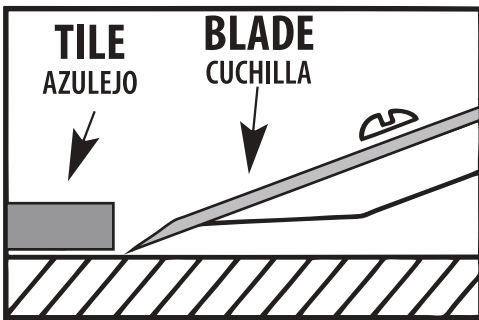

FSB4 (07222) 4" HEAVY-DUTY DOUBLE-EDGE BLADE
4" double-edge blade great for removing tiles or for stripping away floor, wall, or roofing materials.



HEAVY-DUTY FLOOR SCRAPERS

- Removes debris & build-up from flooring, including tiles
- Ideal for manual chiseling to remove materials from floors, walls, roofing & other surfaces.
- Steel tubular handle with comfortable soft-grip
- Heavy-duty die-cast head
- 4" x 4" carbon-steel, double-edge blades
- FS18 includes a hammer end



Learn more about our Heavy-Duty Floor Scrapers

FOR FLOOR, TILE & ROOFING REMOVAL

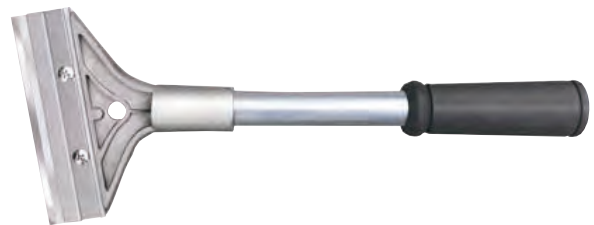

FS5 (07223) 5" HEAVY-DUTY FLOOR & WALL SCRAPER

This makes scraping floors and walls a breeze while providing comfort to the user with its soft grip and sturdy tubular handle.



FSB5 (07224) 5" SINGLE-EDGE FLOOR & WALL SCRAPER BLADE

It features a sharp single edge for optimal scraping performance. Use it for home renovation projects or professional flooring jobs.

PROFESSIONAL WOOD SCRAPERS & BLADES

- Soft grip handle for comfort and all-metal tubular body for durability
- Camber-ground blades for easy removal of paint chips and debris
- Blades are more precise than straight-edged scrapers
- Can be sharpened for longer use
- Suitable for both professionals and DIYers



Learn more about our Professional Wood Scrapers & Blades



FB7 (06004) 50-PIECE TUBULAR WOOD SCRAPER MERCHANDISER

- 5 each: BF1, F42, F22 and F1
- 10 each: 1B, 22B, 42B
- 1 each: universal merchandising rack
- 7 each: 8" grid wall peg hooks



Four Edges

Two for coarse scraping & two for fine scraping.

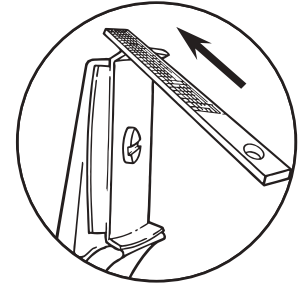

Sharpen Blades

Sharpen edges with blade file during lengthy projects



F42 (06001) 2- 1/2" 4-EDGE TUBULAR WOOD SCRAPER

Ideal for removing paint or varnish from furniture, molding, cornices, sashes, etc.



F22 (06002) 1- 1/2" 4-EDGE TUBULAR WOOD SCRAPER

Ideal for removing paint or varnish from furniture, molding, cornices, sashes, etc.



F1 (06038) 1- 1/8" 2-EDGE SMALL JOB WOOD SCRAPER

Ideal for small woodworking tasks; reaches easily into tight spots.

FOUR EDGE BLADES

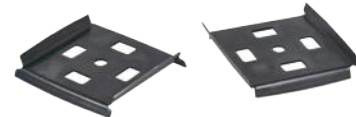

42B (06008) 2- 1/2" 4-EDGE WOOD SCRAPER BLADE

Two edges for fine scraping and two for rough scraping; can be resharpened with a blade file.

22B (06007) 1- 1/2" 4-EDGE WOOD SCRAPER BLADE

Two edges for fine scraping and two for rough scraping; can be resharpened with a blade file.

TWO EDGE BLADES

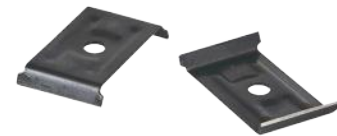

1B (06058) 2- 1/8" 2-EDGE WOOD SCRAPER BLADE

Ideal for small woodworking tasks; reaches easily into tight spots; can produce less dust and a smoother finish compared to sanding with sand paper.

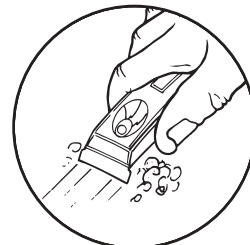

Two Edges

One edge for rough scraping & one for fine scraping.

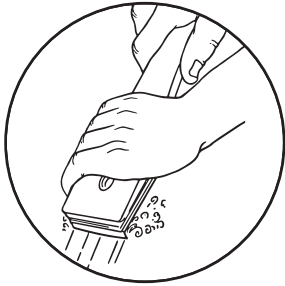

Four Edges

Two for coarse scraping & two for fine scraping.

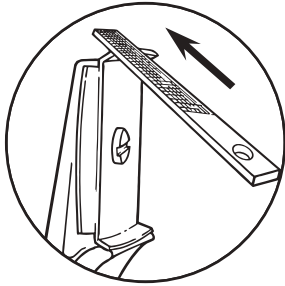

Sharpen Blades

Sharpen edges with blade file during lengthy projects.



F4 (06018) 2- 1/2" 4-EDGE SOFT-GRIP WOOD SCRAPER (NO MINI FILE)

Ideal for removing paint or varnish from furniture, molding, cornices, sashes, etc.

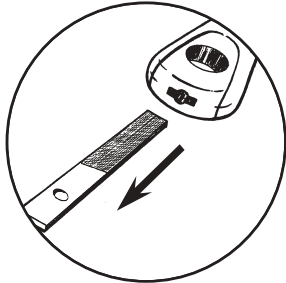

Free Mini File

Pull file forward and remove from handle.



FE4 (06200) 2- 1/2" 4-EDGE SOFT-GRIP WOOD SCRAPER (WITH MINI FILE)

Ideal for removing paint or varnish from furniture, molding, cornices, sashes, etc.



FE2 (06300) 1- 1/2" 4-EDGE SOFT-GRIP WOOD SCRAPER (NO FILE)

Ideal for removing paint or varnish from furniture, molding, cornices, sashes, etc.



FE1 (06400) 1- 1/8" 4-EDGE SOFT-GRIP WOOD SCRAPER (NO FILE)

Ideal for small woodworking tasks; reaches easily into tight spots.

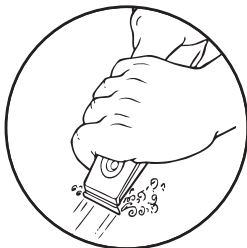

Two Edges

One edge for rough scraping & one for fine scraping.

SOFT-GRIP WOOD SCRAPERS & BLADES

- Designed for comfort and efficiency
- Dual-molded, soft-grip handle for control
- For removing paint or varnish from wood
- Equipped with exclusive camber-ground blades for aggressive scraping action
- Durable blades can be re-sharpened with the included mini file
- Mini file is magnetically retained in the FE4 for added convenience



Learn more about our
Soft-Grip Wood Scrapers &
Blades



FM7 (06048) 50-PIECE SOFT-GRIP WOOD SCRAPER MERCHANDISER

5 each: F4, FE2, FE1, BF1

10 each: 1B, 22B, 42B

1 each: universal merchandising rack

8 each: 8" grid wall peg hooks



BF1 (06005) BLADE FILE

Special flat file made to sharpen blades to a fine, smooth edge.

CONTOUR SCRAPER & BLADES

- Ergonomic soft-grip handle
- Ideal for moldings, reveals, rods, balusters & more
- Includes six stainless-steel blades
- Modify the blade edge with included mini file
- Blades are easy to change
- Patented storage case included



Learn more about our Contour Scraper & Blades

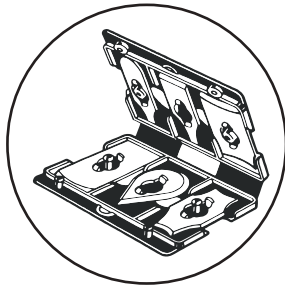

Blade Storage Case

Keep the six blades safely stored and easily accessible.

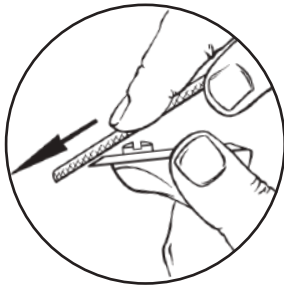

Built-In Blade File

Use half-round side for concave edges; flat side for convex or flat edges.



CS6 Counter Display (19216) contains 6 pieces.

SIX STAINLESS-STEEL CONTOUR BLADES



CS6 (06600) SOFT-GRIP CONTOUR SCRAPER SET

For contour scraping in painting applications.



Blade file inside handle to keep blades at peak sharpness & modify blade edge to fit any contour of surface.



CSB1 (06610) CONTOUR SCRAPER BLADE

For concave indents and narrow reveals.



CSB2 (06620) CONTOUR SCRAPER BLADE

For small flat and small concave molding.



CSB3 (06630) CONTOUR SCRAPER BLADE

For medium and large rods, dowels, convex moldings and balusters.



CSB4 (06640) CONTOUR SCRAPER BLADE

For flat work and large concave moldings, crown moldings and chair rails.



CSB5 (06650) CONTOUR SCRAPER BLADE

For sharp indented moldings, concave moldings, pilasters and mantles.



CSB6 (06660) CONTOUR SCRAPER BLADE

For round moldings, wood curtain rods, door and window casings.

CARBIDE WOOD SCRAPERS & BLADES

- Dual-molded soft-grip handle
- Aluminum construction for long-lasting use
- Built-in hammer end
- Tungsten carbide blades for scraping paint quickly & cleanly
- Ideal for flat & corner scraping
- Stays sharper 50x longer than a standard carbon-steel blade

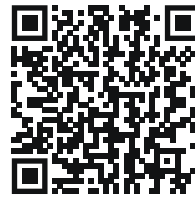

Learn more about our
Carbide Wood Scrapers & Blades

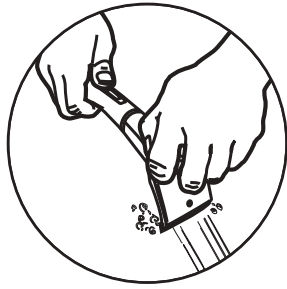

Extra Pressure

Knob allows extra leverage when aggressively scraping.

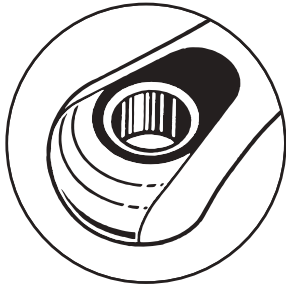

Hammer End

Drives loose nails or screws in place.



CBS25 (06510) 2- 1/2" SOFT-GRIP CARBIDE SCRAPER, HAMMER END
Ideal for removal of paint, glue, varnish, rust, gaskets etc.; knob for two-handed pressure during heavy-duty projects.



CBS20 (06520) 2" SOFT-GRIP CARBIDE SCRAPER, HAMMER END
Ideal for removal of paint, glue, varnish, rust, gaskets etc.



CBS10 (06530) 1" SOFT-GRIP CARBIDE SCRAPER, HAMMER END
Ideal for precise scraping of paint, glue, varnish, rust, gaskets in tight places.

DOUBLE-EDGE BLADES



CB25 (06540) 2- 1/2" DOUBLE-EDGE CARBIDE SCRAPER BLADE
Features a diamond-honed curved edge that allows for aggressive scraping without digging in and gouging the wood or surface being scraped.

CB20 (06550) 2" DOUBLE-EDGE CARBIDE SCRAPER BLADE
Features a diamond-honed curved edge that allows for aggressive scraping without digging in and gouging the wood or surface being scraped.



Contoured Blade Edges

Helps prevent gouging or scratching; more thorough and efficient scraping than flat contour blades.

TRIPLE-EDGE BLADES



CB10 (06560) 1" TRIPLE-EDGE CARBIDE SCRAPER BLADE
When one edge dulls, loosen the blade with a screwdriver and rotate to a fresh cutting edge.



CBSM6 (06570) 30-PIECE SOFT-GRIP CARBIDE SCRAPER MERCHANDISER

Contains 5 each: CBS25, CBS20, CBS10, CB25, CB20 & CB10

Contains 1 each: universal merchandising rack

Contains 6 each: 8" grid wall peg hooks

MULTI-PURPOSE SCRAPERS

- Heavy-duty chiseled blades
- For scraping, flooring & other heavy-duty jobs
- Die-cast hammer end
- Remove hammer end to reveal threads to use with extension pole
- Soft-grip with contour fingered grips
- 3" fixed, heavy-duty blades



Learn more about our
Multi-Purpose Scrapers

FOR SCRAPING PEELING & CAKED ON PAINT

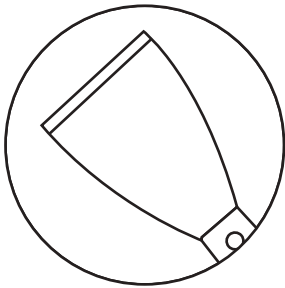

3" Heavy-Duty Blade
Made from high-quality carbon steel.



Compatible
Ideal for use with a heat gun.



LS3 (09015) LONG WOOD-HANDLE BURN OFF SCRAPER
3" blade is made from high-quality carbon steel that has been heat-treated, tempered, ground and polished



BS3 (09055) 3" SOFT-GRIP BENT SCRAPER, POLE SOCKET & HAMMER END
Bent profile creates extra clearance while in use to help keep walls and floors safe from damage and to protect knuckles from scratches.



FS3 (09060) 3" SOFT-GRIP FLAT SCRAPER, HAMMER END
Ideal for heavy-duty scraping jobs, like removing wall coverings, paint, silicone, scale or even tiles.



BG1 (09081) EXTENDABLE HEAVY-DUTY 8-IN-1 TOOL, HAMMER END
Serves as a spreader, chisel scraper, crack & can opener, roller cleaner, nail puller; removable hammer end reveals a threaded socket for use with extension pole.



F42X (06100) SOFT-GRIP EXTENDABLE PUSH/PULL SCRAPER, HAMMER END
Ideal for heavy-duty scraping jobs, like removing wall coverings, paint, silicone, scale or even tiles; can clear out old paint chips & debris from surfaces; see page 17 for more info regarding the 4-edge blade.

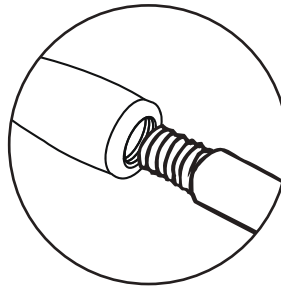

Extendable
For hard-to-reach areas, remove the hammer end and insert a threaded pole.

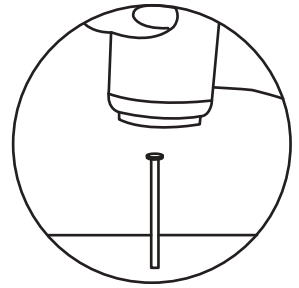

Hammer end
Taps in loose nails or screws.



BS3-DSP (19206) 10-PIECE COUNTER DISPLAY
Contains 10 each: BS3.



UX15F (09401) 1-1/2" UNIBODY STAINLESS-STEEL PUTTY KNIFE

Small size is ideal for use in tight areas and awkward angles.

UX2F (09402) 2" UNIBODY STAINLESS-STEEL PUTTY KNIFE

UX3F (09403) 3" UNIBODY STAINLESS-STEEL JOINT KNIFE

UX4F (09404) 4" UNIBODY STAINLESS-STEEL JOINT KNIFE

Ideal for picking angles, hand taping angles, and covering screws and wall patches.

UX5F (09405) 5" UNIBODY STAINLESS-STEEL JOINT KNIFE

UX6F (09406) 6" UNIBODY STAINLESS-STEEL JOINT KNIFE

UXG12 (09407) 12-IN-1 UNIBODY STAINLESS-STEEL PAINTER'S MULTI-TOOL

Serves as a spreader, smoother, chisel scraper, crack & can opener, roller cleaner, 3/4", 3/8" & 5/8" nut wrench, bottle opener, nail puller; built-in hammer end.

UX8F (09408) 8" UNIBODY STAINLESS-STEEL JOINT KNIFE

Ideal for wiping tape, smoothing out wide lines of compound, patching tub surrounds, and working larger patches.

UX10F (09410) 10" UNIBODY STAINLESS-STEEL JOINT KNIFE

UXG-3PK (41025) 3-PIECE UNIBODY STAINLESS-STEEL JOINT KNIFE SET

Consists 1 each: UX3F, UX6F, UXG12

UNIBODY STAINLESS STEEL (UX-LINE)

- Rust-free stainless steel
- One-piece "unibody" construction
- Professionally hollow-ground, mirror-polished flexible blade
- Built-in hammer end
- Easy to clean
- Long ergonomic handle
- Excellent balance in use



Learn more about our UX-line of putty & joint knives

SOFT-GRIP STAINLESS STEEL (SX-LINE)

- Rust-free stainless steel
- Professionally hollow-ground flex blade or taper ground stiff blade
- True full-tang construction for durability
- Ergonomic, soft-grip handle
- Includes screwdriver bit
- Hammer end taps in loose nails



SXCH (09197) 1-1/4" SOFT-GRIP CHISEL

Perfect for precise scraping and shaping of putty or other materials.

SX15F (09190) 1-1/2" SOFT-GRIP FLEX PUTTY KNIFE

Small size is ideal for use in tight areas and awkward angles.

SX15S (09195) 1-1/2" SOFT-GRIP STIFF WALL SCRAPER

SX3F (09180) 3" SOFT-GRIP FLEX PUTTY KNIFE

SX3S (09185) 3" SOFT-GRIP STIFF WALL SCRAPER

SX4F (09175) 4" SOFT-GRIP FLEX JOINT KNIFE

Ideal for picking angles, hand taping angles, and covering screws and wall patches.

SX5F (09170) 5" SOFT-GRIP STIFF JOINT KNIFE

SX6F (09165) 6" SOFT-GRIP FLEX JOINT KNIFE

SX8F (09168) 8" SOFT-GRIP FLEX JOINT KNIFE

Ideal for wiping tape, smoothing out wide lines of compound, patching tub surrounds, and working larger patches.

SX10F (09160) 10" SOFT-GRIP FLEX JOINT KNIFE

SXG1 (09196) 8-IN-1 SOFT-GRIP PAINTER'S MULTI-TOOL

Serves as a scraper, chisel, nail puller, crack & can opener, roller cleaner & spackle/adhesive spreader; hammer end sets loose nails or screws.



Learn more about our SX-line of putty & joint knives

SOFT-GRIP CARBON STEEL (DSX-LINE)

- High-carbon steel blades are polished & lacquered with clear coating
- Professionally hollow-ground flex blade or taper ground stiff blade
- Heavy-duty hammer end
- Long ergonomic, soft-grip handle
- Excellent balance in use



Learn more about our DSX-line of putty & joint knives



DSXCH (19197) 1-1/4" SOFT-GRIP CHISEL

Perfect for precise scraping and shaping of putty or other materials.

DSX15F (19190) 1-1/2" SOFT-GRIP FLEX PUTTY KNIFE

Small size is ideal for use in tight areas and awkward angles.

DSX15S (19195) 1-1/2" SOFT-GRIP STIFF WALL SCRAPER

DSX2F (19192) 2" SOFT-GRIP FLEX PUTTY KNIFE

DSX2S (19191) 2" SOFT-GRIP STIFF WALL SCRAPER

DSX3F (19180) 3" SOFT-GRIP FLEX PUTTY KNIFE

DSX3S (19185) 3" SOFT-GRIP STIFF WALL SCRAPER

DSX4F (19175) 4" SOFT-GRIP FLEX JOINT KNIFE

Ideal for picking angles, hand taping angles, and covering screws and wall patches.

DSX5F (19170) 5" SOFT-GRIP FLEX JOINT KNIFE

DSX6F (19165) 6" SOFT-GRIP FLEX JOINT KNIFE

DSXG1 (19196) 6-IN-1 SOFT-GRIP PAINTER'S MULTI-TOOL

Serves as an adhesive spreader, chisel scraper, paint can & crack opener, roller cleaner, nail puller; heavy-duty hammer end.

DSXG16 (09211) 16-IN-1 SOFT-GRIP PAINTER'S MULTI-TOOL



NX15F (09501) 1-1/2" ERGONOMIC NYLON-HANDLE FLEX PUTTY KNIFE

Ideal for use in tight areas and awkward angles.

NX15S (09502) 1-1/2" ERGONOMIC NYLON-HANDLE STIFF SCRAPER

NX3F (09503) 3" ERGONOMIC NYLON-HANDLE FLEX PUTTY KNIFE

NX3S (09504) 3" ERGONOMIC NYLON-HANDLE STIFF WALL SCRAPER

NX3PT (41062) 3-1/2" ERGONOMIC NYLON-HANDLE POINTING KNIFE

The pointing shape of the blade makes it ideal for finishing tight corners with finesse.

NX4F (09505) 4-1/2" ERGONOMIC NYLON-HANDLE FLEX JOINT KNIFE

Ideal for picking angles, hand taping angles, and covering screws and wall patches.

NX6F (09506) 6" ERGONOMIC NYLON-HANDLE FLEX JOINT KNIFE

NX6CL (41061) 6" ERGONOMIC NYLON-HANDLE CLIPPED KNIFE

Its clipped shape is perfect for maneuvering in tight corners.

NXG1 (09507) 6-IN-1 ERGONOMIC NYLON-HANDLE PAINTER'S MULTI-TOOL

Serves as a scraper, chisel, crack & can opener, roller cleaner & spackle/adhesive spreader; hammer end sets loose nails or screws.

ERGONOMIC NYLON HANDLE (NX-LINE)

- High-carbon steel blades are polished & lacquered with clear coating
- Professionally hollow-ground flex blades spread compound smoothly
- Professionally taper-ground stiff blades scrape & prep
- Longer, more ergonomic handle than the classic X-line
- Dual-rivet construction
- Hammer end in 4", 6" & 6-in-1 multi-tool



Learn more about our NX-line of putty & joint knives



- XCH1-1/4 (09001) 1-1/4" NYLON-HANDLE CHISEL**
- X-3/4F (08997) 3/4" NYLON-HANDLE FLEX DETAIL PUTTY KNIFE**
- X-3/4S (08999) 3/4" NYLON-HANDLE STIFF DETAIL CHISEL**
- X1-1/4F (09002) 1-1/4" NYLON-HANDLE FLEX PUTTY KNIFE**
- X1-1/4S (09003) 1-1/4" NYLON-HANDLE STIFF SCRAPER**
- X1-1/2F (09004) 1-1/2" NYLON-HANDLE FLEX PUTTY KNIFE**
- X1-1/2S (09005) 1-1/2" NYLON-HANDLE STIFF SCRAPER**
- X2F (09006) 2" NYLON-HANDLE FLEX PUTTY KNIFE**
- X2S (09007) 2" NYLON-HANDLE STIFF SCRAPER**
- X3F (09008) 3" NYLON-HANDLE FLEX PUTTY KNIFE**
- X3S (09009) 3" NYLON-HANDLE STIFF SCRAPER**
- X4F (09010) 2" NYLON-HANDLE STIFF SCRAPER**
- X5F (09011) 5" NYLON-HANDLE FLEX PUTTY KNIFE**
- X6F (09012) 6" NYLON-HANDLE FLEX JOINT KNIFE**
- XG1 (09013) 6-IN-1 NYLON-HANDLE PAINTER'S MULTI-TOOL**
- X6BIT (09027) 6" NYLON-HANDLE JOINT KNIFE, SLIDING PHILLIPS SCREWDRIVER BIT**

VINTAGE NYLON HANDLE (X-LINE)

- High-carbon steel blades are polished & lacquered with clear coating
- Professionally hollow-ground flex blades spread compound smoothly
- Professionally taper-ground stiff blades scrape & prep
- Classic nylon-handle design
- Dual-rivet construction



Learn more about our X-line of putty & joint knives

ALL-STAINLESS STEEL (T-LINE)

- Durable stainless-steel construction
- Professionally hollow-ground flex blades spread compound smoothly
- Professionally taper-ground stiff blades scrape & prep
- Ultra-durable
- Easy to clean & will not corrode
- Slides in & out of pocket easily
- A go-tool for handyman since the 1960s



Learn more about our T-line of putty & joint knives

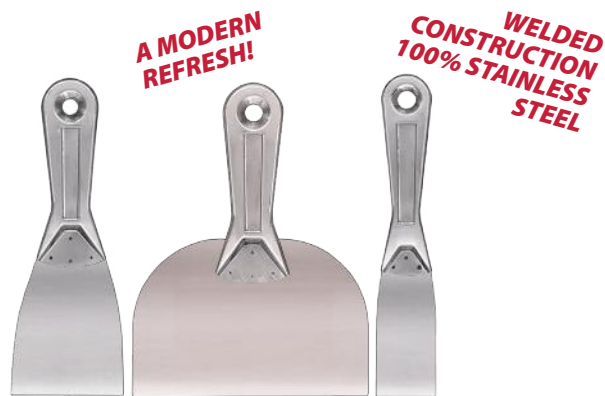

- T15F (08001) 1-1/2" TWO-PIECE STAINLESS-STEEL FLEX PUTTY KNIFE**
Small size is ideal for use in tight areas and awkward angles.
- T15S (08002) 1-1/2" TWO-PIECE STAINLESS-STEEL STIFF PUTTY KNIFE**
- T30F (08003) 3" TWO-PIECE STAINLESS-STEEL FLEX PUTTY KNIFE**
- T30S (08004) 3" TWO-PIECE STAINLESS-STEEL STIFF PUTTY KNIFE**
- T45(08005) 4-1/2" TWO-PIECE STAINLESS-STEEL JOINT KNIFE**
Ideal for picking angles, hand taping angles, and covering screws and wall patches.
- T60 (08006) 6" TWO-PIECE STAINLESS-STEEL JOINT KNIFE**
- T100 (08007) 10" TWO-PIECE STAINLESS-STEEL TAPE KNIFE**
Use for drywall joint taping, finishing and patching, smoothing and trimming wallcoverings, and removing popcorn ceilings.
- TG1 (08008) 5-IN-1 TWO-PIECE STAINLESS-STEEL PAINTER'S MULTI-TOOL**
Serves as a scraper, chisel, crack & can opener, roller cleaner & spackle/adhesive spreader.
- TG1-25 (08009) 10" TWO-PIECE STAINLESS-STEEL TAPE KNIFE, 25 PER BUCKET**

ECONOMIC PLASTIC HANDLE (PT-LINE)

- High-carbon steel blade
- Professionally hollow-ground flex blades spread compound smoothly
- Professionally taper-ground stiff blades scrape & prep
- Ergonomic, lightweight plastic handle



Learn more about our PT-line of putty & joint knives



PT15F (08018) 1- 1/2" ECONOMY PUTTY KNIFE

Small size is ideal for use in tight areas and awkward angles.

PT15S (08019) 1- 1/2" ECONOMY STIFF WALL SCRAPER

PT30F (08020) 3" ECONOMY FLEX PUTTY KNIFE

PT30S (08021) 3" ECONOMY STIFF WALL SCRAPER

PT45 (08022) 4- 1/2" ECONOMY FLEX JOINT KNIFE

Ideal for picking angles, hand taping angles, and covering screws and wall patches.

PT60 (08023) 6" ECONOMY FLEX JOINT KNIFE

PTG1 (08025) 5-IN-1 ECONOMY PAINTER'S MULTI-TOOL

Serves as a scraper, chisel, crack & can opener, roller cleaner & spackle/adhesive spreader.



SG1 (09016) 5-IN-1 SOFT-GRIP PAINTER'S MULTI-TOOL

Serves as a spreader, chisel scraper, crack & can opener, roller cleaner.

CELCON

Greater strength & heat resistance



POLYPRO

Cost effective and more moisture resistance

- DS15 (08115) 1- 1/2" CELCON PUTTY KNIFE, 25 PER BUCKET**
- DS15P (18215) 1- 1/2" POLYPRO PUTTY KNIFE**
- DS20 (08120) 2" CELCON PUTTY KNIFE, 25 PER BUCKET**
- DS20P (18220) 2" POLYPRO PUTTY KNIFE**
- DS30 (08113) 3" CELCON PUTTY KNIFE, 25 PER BUCKET**
- DS30P (18230) 3" POLYPRO PUTTY KNIFE**
- DS30U-10 (08134) 3" CELCON U-NOTCH SPREADER, 10 PER BOX**
- DS30V (08133) 3" CELCON V-NOTCH SPREADER, 25 PER BUCKET**
- DS30V-10 (08133) 3" CELCON V-NOTCH SPREADER, 10 PER BOX**
- DS40 (08140) 4" CELCON PUTTY KNIFE, 25 PER BUCKET**
- DS40P (18240) 4" POLYPRO PUTTY KNIFE**
- DS60 (08600) 6" CELCON JOINT KNIFE, 25 PER BUCKET**
- DS60P (18260) 6" POLYPRO JOINT KNIFE**
- DS-3PK (08835) 3-PIECE CELCON PUTTY KNIFE SET, 1- 1/2", 3" & 6"**
- DS-3PKL (08838) 3-PIECE POLYPRO PUTTY KNIFE SET, 1- 1/2", 3" & 6"**
- DS-3PKS (08834) 3-PIECE POLYPRO PUTTY KNIFE SET, 1- 1/2", 2" & 3"**

CELCON (POM) & POLYPRO (PP)

- Easy clean-up
- Solvent-proof plastic
- Celcon has greater strength & heat resistance
- Polypropylene has more moisture resistance
- Lightweight & comfortable to grip
- Allows for light scraping on surfaces
- Perfect for one-time use such as spreading compound, caulking, etc.



DSH (08750) 3" CELCON PAINT STRIPPER/SCOOPER

For scraping paint, residue and adhesive off flat surfaces and quickly scooping up the mess.

SD3 (18213) 3-PIECE CELCON DETAIL PUTTY KNIFE SET, 3/8", 5/8" & 1"

Ideal for spreading joint compound, spackle or adhesive.

PRO STAINLESS STEEL (UTK-LINE)

- 100% stainless-steel construction
- Ergonomic & easy to clean
- Strong-dual rivets attach blade to handle
- Integrated hammer end
- Use for drywall joint taping, finishing and patching, smoothing and trimming wallcoverings, and removing popcorn ceilings
- Available in 8", 10", 12" & 14"



UTK8 (21501) 8" PRO STAINLESS-STEEL TAPING KNIFE

Ideal for patching small holes, cracks, or imperfections.

UTK10 (21502) 10" PRO STAINLESS-STEEL TAPING KNIFE

Provides a balance between precision and surface coverage.

UTK12 (21503) 12" PRO STAINLESS-STEEL TAPING KNIFE

Covers larger areas efficiently, reducing the number of passes needed.

UTK14 (21504) 14" PRO STAINLESS-STEEL TAPING KNIFE

Maximizes coverage for large drywall surfaces, saving time and effort.

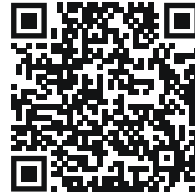

Learn more about our UTK-line of taping knives

SOFT-GRIP STAINLESS STEEL (STKB-LINE)

- Premium stainless-steel blades
- Dual-sided screwdriver bit (#2 Phillips & #2 slotted) included in handle
- Ergonomic soft-grip handle
- Built-in hammer end
- Use for drywall joint taping, finishing and patching, smoothing and trimming wallcoverings, and removing popcorn ceilings
- Available in 8", 10", 12" & 14"
- Patented



Learn more about our STKB-line of taping knives



STKB8 (21511) 8" SOFT-GRIP STAINLESS-STEEL TAPING KNIFE

Ideal for patching small holes, cracks, or imperfections.

STKB10 (21512) 10" SOFT-GRIP STAINLESS-STEEL TAPING KNIFE

Provides a balance between precision and surface coverage.

STKB12 (21513) 12" SOFT-GRIP STAINLESS-STEEL TAPING KNIFE

Covers larger areas efficiently, reducing the number of passes needed.

STKB14 (21514) 14" SOFT-GRIP STAINLESS-STEEL TAPING KNIFE

Maximizes coverage for large drywall surfaces, saving time and effort.

SOFT-GRIP BLUE STEEL (BTK-LINE)

- Professional blue-spring steel blade
- Built-in hammer end
- Lightweight & easy to handle
- Full ergonomic, soft-grip handle
- Use for drywall joint taping, finishing and patching, smoothing and trimming wallcoverings, and removing popcorn ceilings
- Available in 8", 10", 12" & 14"



Learn more about our BTK-line of taping knives



BTK8 (11800) 8" SOFT-GRIP BLUE-STEEL TAPING KNIFE

Ideal for patching small holes, cracks, or imperfections.

BTK10 (11000) 10" SOFT-GRIP BLUE-STEEL TAPING KNIFE

Provides a balance between precision and surface coverage.

BTK12 (11200) 12" SOFT-GRIP BLUE-STEEL TAPING KNIFE

Covers larger areas efficiently, reducing the number of passes needed.

BTK14 (11400) 14" SOFT-GRIP BLUE-STEEL TAPING KNIFE

Maximizes coverage for large drywall surfaces, saving time and effort.

TEXTURED-GRIP BLUE STEEL (TK-LINE)

- Professional blue-spring steel blade
- Textured soft-grip, non-slip handle
- Use for drywall joint taping, finishing and patching, smoothing and trimming wallcoverings, and removing popcorn ceilings
- Available in 8", 10", 12"

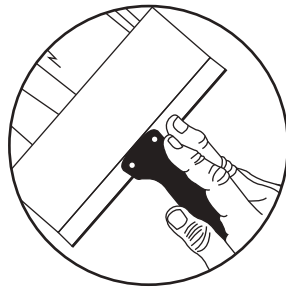

TK8 (10800) 8" TEXTURED-GRIP BLUE-STEEL TAPING KNIFE

Ideal for patching small holes, cracks, or imperfections.

TK10 (10101) 10" TEXTURED-GRIP BLUE-STEEL TAPING KNIFE

Provides a balance between precision and surface coverage.

TK12 (10120) 12" TEXTURED-GRIP BLUE-STEEL TAPING KNIFE

Covers larger areas efficiently, reducing the number of passes needed.



Learn more about our TK-line of taping knives



MP (13070) 12" PLASTIC DRYWALL MUD PAN

Two steel wiping edges that are blackened to resist corrosion; tapered ends & sides for easy mud removal.

LEAKPROOF & LASER-WELDED MUD PANS



MPX12 (13073) 12" STAINLESS-STEEL LASER-WELDED MUD PAN

MPX14 (13074) 14" STAINLESS-STEEL LASER-WELDED MUD PAN

Laser-welded seams guarantee a watertight construction, preventing drips and leaks.

FOR REPAIRING DAMAGED WALLS & CEILINGS

IDEAL FOR SMALL REPAIR JOBS ON DAMAGED WALLS & CEILINGS



DW5PK (10700) 5-PIECE DRYWALL REPAIR KIT

10" soft-grip blue-steel tapping knife - for spreading compound
 12" plastic drywall mud pan - for scraping your joint or tapping knife
 6" nylon-handle joint knife - for spreading and smoothing compound
 Medium-grit sanding sponge - remove any surface imperfections
 50' roll of mesh tape - for a professional, flat finish

DRYWALL MUD PANS

- Essential tools for drywall finishing
- Carries drywall compound
- Tapered ends & sides make it comfortable to hold
- Easy to clean
- Stainless-steel varieties last longer & provide superior performance
- Available in 12" & 14"

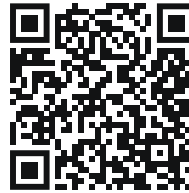

Learn more about our Drywall Mud Pans

ULTIMATE DRYWALL REPAIR ASSORTMENT



DWRA (48009) 66-PIECE DRYWALL REPAIR ASSORTMENT

10 each: UPS, UHS, DWS & DSS
 4 each: DW5PK
 6 each: HMA
 5 each: BTK8, BTK10 & BTK12
 1 each: SS100
 8 each: 8" grid wall peg hooks
 1 each: universal merchandising rack

DRYWALL TAPER BANJO

- Holds 500 ft. of tape and 40 ft. of compound
- Adjustable valve for precise compound control
- Lightweight aluminum with an ergonomic hardwood handle
- Nylon side handle with thumb rest and serrated cut-off blade
- One-handed loading saves time and reduces labor



Learn more about our
Drywall Taper Banjo

AVOID TYPICAL DRYWALL REPAIR FRUSTRATIONS



1 Pour drywall mud into the compartment.



2 Thumb screw controls the rate of the compound being poured.



3 Run taping tool along the seam.



4 Smooth with joint or taping knife.

HOLDS UP TO FIVE HUNDRED LINEAR FEET OF DRYWALL TAPE



DTBA (41058) QUICK-LOAD DRYWALL TAPER BANJO
Includes a pilot drill, a tapered hole saw and two drywall pugs.

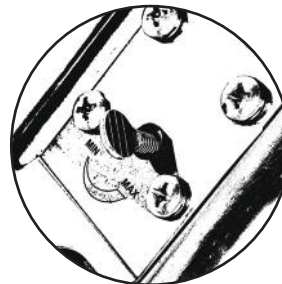

Thumb Screw

Adjust it to control the flow rate of compound.



Serrated Cutting Blades

Quickly & cleanly cuts tape to the desired length.

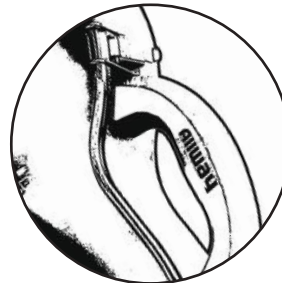

Compartment Latch

Provides a secure, leak-free seal.

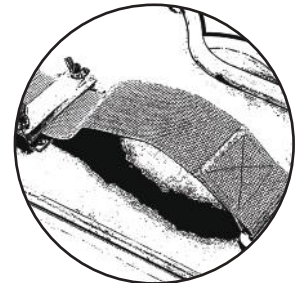

Adjustable Strap

Provides comfort & control, especially during long-term projects.



EHS (41026) ECONOMY SPRING-LOADED HAND SANDER

EPS (41027) ECONOMY SPRING-LOADED POLE SANDER

MPS (41028) ALUMINUM SPRING-LOADED POLE SANDER



UPS (13010) HEAVY-DUTY POLE SANDER

PHS (13015) SOFT-GRIP PALM SANDER

UHS (13020) HEAVY-DUTY HAND SANDER

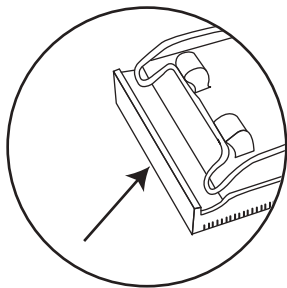

Integrated, Molded Pad

Acts as a bumper to protect walls from being marred during the use.

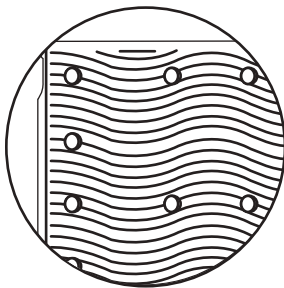

Grippy Bottom

Provides better sanding performance.

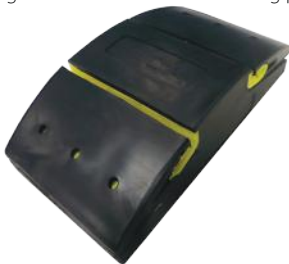

RB1 (10008) RUBBER SANDING BLOCK



ANP (13040) ABRASIVE NYLON PADS, 80-GRIT 2-PACK

DSS (13080) DRYWALL SANDING SCREENS, 220-GRIT, 2-PACK

DWS (13030) DRYWALL SANDING SHEETS, 100-GRIT, 3-PACK

HAND & POLE SANDERS

- Make tough sanding jobs easier
- Hand sanders such as the UHS, PHS & EHS are great for detailed work
- Pole sanders such as the EPS, MPS & UPS let you reach high or low areas
- Grippy bottoms for better control
- Solid structural foam construction
- Two stainless-steel clips hold sheets tightly & securely in place on UPS, PHS & UHS
- EPS, EHS & MPS have a wing-nut clamp for fast sandpaper changes

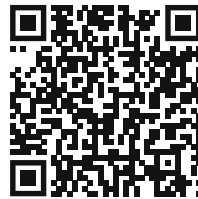

Learn more about our Hand & Pole Sanders



PHS-DSP (19207) 5-PIECE COUNTER DISPLAY

UHS-DSP (19212) 8-PIECE COUNTER DISPLAY



UPS-DSP (19211) 10-PIECE COUNTER DISPLAY

WALL-EZ™ DRYWALL REPAIR SYSTEM

- All-in-one, mess-free drywall solution
- Professional results with minimal effort
- Restores a flat surface & strengthens drywall in minutes
- Ideal for repairing damage from doorknobs, water, electrical work or drill-and-fill insulation
- Kit includes pilot drill, tapered hole saw & two replacement drywall plugs
- Made in the USA



Learn more about our Wall-EZ™ Drywall Repair System

AVOID TYPICAL DRYWALL REPAIR FRUSTRATIONS



1 Locate wall damage or access point & drill hole around damaged area.



2 Apply compound around the rim and install the plugs into the hole.



3 Once compound is applied, smooth it out with a joint knife.



4 Sand down the imperfections & apply matching paint to finish the repair job.

REPAIRS DAMAGED AREAS UP TO 3"



WEK2 (13090) WALL-EZ™ DRYWALL REPAIR KIT

Includes a pilot drill, a tapered hole saw and two drywall plugs.

WEP2 (13091) WALL-EZ™ DRYWALL REPAIR PLUGS, 2-PACK

Includes two drywall plugs (pilot drill & tapered hole saw are not included).



WEP30 (13092) WALL-EZ™ DRYWALL REPAIR PLUGS, 30-PACK

Includes thirty drywall plugs (pilot drill & tapered hole saw are not included).



WED20 (13093) 20-PIECE WALL-EZ™ DRYWALL REPAIR COUNTER-DISPLAY

Includes 7 WALL-EZ™ Drywall Repair Kits & 13 WALL-EZ™ Drywall Repair Plugs.



- WP4 (13044) 4" x 4" DRYWALL REPAIR PATCH**
- WP6 (13066) 6" x 6" DRYWALL REPAIR PATCH**
- WP8 (13088) 8" x 8" DRYWALL REPAIR PATCH**



- WP4-3 (13344) 4" x 4" DRYWALL REPAIR PATCH, 3-PACK**
- WP6-3 (13366) 6" x 6" DRYWALL REPAIR PATCH, 3-PACK**

DRYWALL REPAIR PATCHES

- For quick, easy repairs on walls, ceilings & doors
- Lightweight & rust-proof
- Fiberglass mesh over perforated aluminum plate
- Full adhesive back allows for easy peel & stick application
- Can be cut to specific size needed
- Available in 4", 6" & 8"

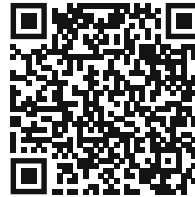

Learn more about our
Drywall Repair Patches

WALL SHIELDS

- Pressure-sensitive pads designed to protect walls from damage caused by doorknobs
- Prevents dents & marks
- Simply peel & stick
- Blend seamlessly with wall surfaces & be painted to match décor
- Available in two sizes—3-1/2" and 4-3/4"

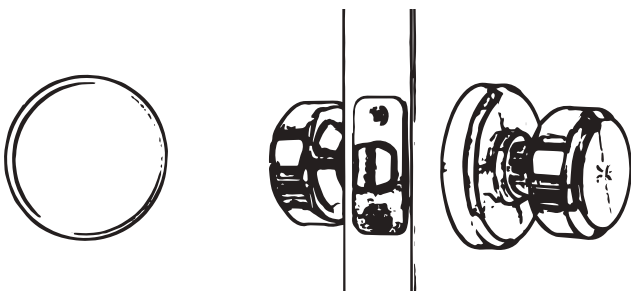

EASILY BLENDS WITH WALL SURFACES



- WS35 (13045) WALL SHIELD, 2-PACK**

CORNER TOOLS

- Essential for plasterers
- They create smooth, clean, and professional corners quickly, whether inside or outside
- Apply joint compound precisely and reinforce drywall corners for durability
- Inside corner tools ensure even seams
- Outside corner tools keep finishes straight
- Professionals achieve perfect results on both types of corners
- Getting the job done in less time



Learn more about our
Corner Tools

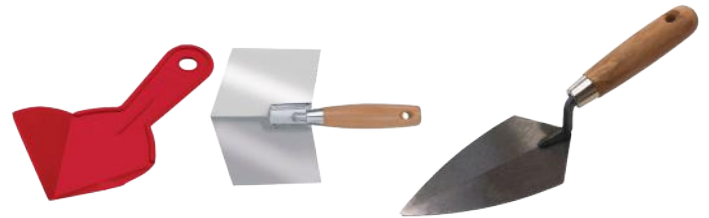

DCT (08850) PLASTIC CORNER TOOL

The flexible moving edges ensure that you have the necessary flexibility to shape the compound just the way you want it, without any cracking or breaking.

CT (13060) STAINLESS-STEEL INSIDE CORNER TOOL

Enables forming compound in internal corners and smoothing application along.

PT5 (15080) 5-1/2" POINTING TROWEL

Enables forming compound in internal corners and smoothing application along.



CTS21 (13061) 2-IN-1 DRYWALL CORNER TOOL SET

Enables forming compound in internal corners and smoothing application along external corners in a single pass.



HWK (13100) 13" x 13" DRYWALL HAWK

Holds and distributes drywall mud and cement.

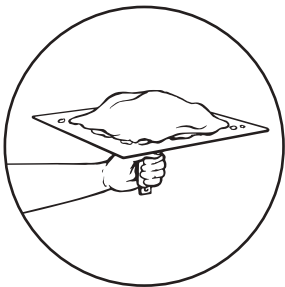

Structural Foam Scoop

Holds drywall mud & cement



Pole Socket

Can fit extension pole for greater reach.



HWK13AL (41067) 13" x 13" ALUMINUM DRYWALL HAWK

Its densely grooved aluminum plate ensures easy cleanup and a longer lifespan, while the rounded corners provide enhanced safety.

DRYWALL HAWKS

- Drywall hawks are essential for anyone working with drywall or plaster
- They provide a stable surface for holding and moving joint compound
- Help apply smooth, even coats to walls and ceilings
- The flat surface allows quick access to the compound
- Keeps hands free for using the trowel
- Reduces trips to the compound bucket
- Ideal for smoothing seams, filling gaps, and detailed work



Learn more about our
Drywall Hawks

DRYWALL RASP

- Removes more material per stroke than regular rasps for faster work
- Tough plastic body with an open design prevents clogging
- Rubber grips provide a comfortable, less tiring hold
- Bi-directional blade reduces cutting time
- Easy-to-replace blade for continued efficiency



RASP (41035) SOFT-GRIP DRYWALL RASP
Bi-directional functionality for increased efficiency and reduced job time.

SMALL HOLE FILLER REPAIR KITS

- Fastest way to fix nail holes, cracks, and small surface damage on drywall, wood, stucco, etc
- Each kit includes pre-measured spackle and a built-in spreader/smoothen edge
- Simply snap open the pod, squeeze to fill, and use the spreader to smooth
- Includes six kits, making it easy to store



SNP6 (13095) SMALL HOLE FILLER REPAIR KITS, 6-PACK
Fills up to 30 typical size nail holes in drywall, wood, stucco and particle board.
SNP6-DSP (19219) 24-PIECE COUNTER DISPLAY



DJS (04040) WOOD-HANDLE DRYWALL JAB SAW
Sleek wood handle allows for a comfortable grip that will not strain your hands.

**DESIGNED FOR SMOOTHER
PUSH CUTTING &
EASIER PUNCTURING**



SDJS (04140) SOFT-GRIP DRYWALL JAB SAW
Built to enhance your grip and reduce the risk of slipping – a must-have utility saw for professionals and do-it-yourself projects

DRYWALL JAB SAWS

- Designed for comfort and easy cutting.
- 6-1/2" blade cuts through drywall quickly, ideal for switch plates and outlets
- Forward-facing teeth provide smoother cuts and easy puncturing
- Reinforced blade back prevents sticking.
- Sharp tip allows for easy cut starts
- DJS model features a sturdy wood handle
- SDJS model has an improved grip to prevent slipping
- Both tools are essential for drywall work



**Learn more about our
Drywall Jab Saws & Rasp**

HELIX MIXERS

- Quickly mixes deep epoxies, resins, latex and oil paints, coatings & other viscous liquids
- Patented helix shape ensures complete mixing while creating less air bubbles
- Reaches corners and the bottom of the can
- Plastic vanes will not damage buckets or cans
- Cleanup is easy—just wipe them down after use
- Hex shaft that provide a secure compatibility with most electric drills in the market
- Insert mixer into a drill, tighten & use
- Use a low to moderate speed & make sure not to raise mixer above the surface to avoid messes



Learn more about the ALLWAY Helix Mixers

ALSO LOOK AT OUR HEAVY-DUTY MIXERS



HDM (10030) HEAVY-DUTY MUD MIXER

Ideal for mixing mortar, thin set, drywall joint compound, acoustic texture and other construction materials.



SM1 (10025) 1-GALLON ALL-STEEL SPIRAL MIXER

Spiral design helps mix paint, mud and other types of compound fast and evenly in 1-gallon buckets.



SM5 (10053) 5-GALLON ALL-STEEL SPIRAL MIXER

Spiral design helps mix paint, mud and other types of compound fast and evenly in 5-gallon buckets.



HMQ (10034) QUART/CUP HELIX MIXER, 2-PACK

The perfect size to mix small to medium-sized batches of paint, resin or epoxy.

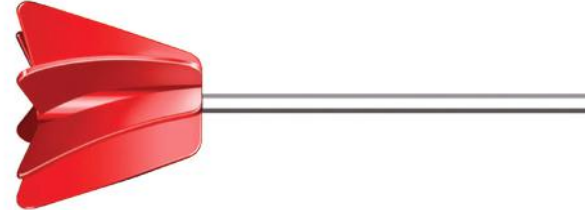

HM1 (10031) 1-GALLON HELIX MIXER

Ideal for mixing paints and other liquids in 1 gallon cans or buckets.



HM5 (10032) 5-GALLON HELIX MIXER

Ideal for mixing paints and other liquids in 5 gallon cans or buckets.

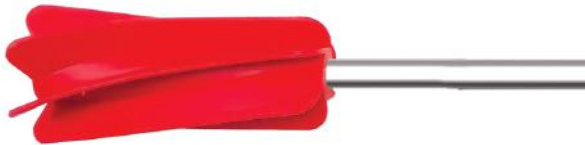

HM5N (10038) 5-GALLON HELIX NARROW MIXER

The innovative narrow head allows the mixer head to fit down inside 5-gallon buckets through the bung hole, saving time and minimizing the risk of spillage.

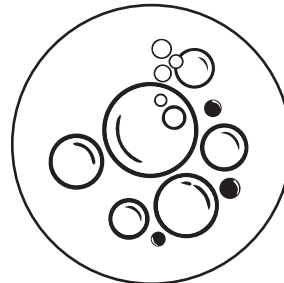

Less Air Bubbles

Makes it ideal for epoxies and other finer finishing products.

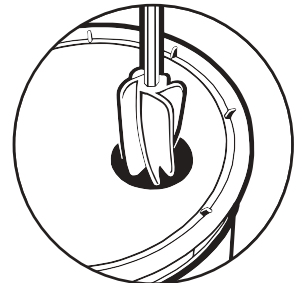

Innovative Narrow Head

Saves time and minimizes the risk of spillage.

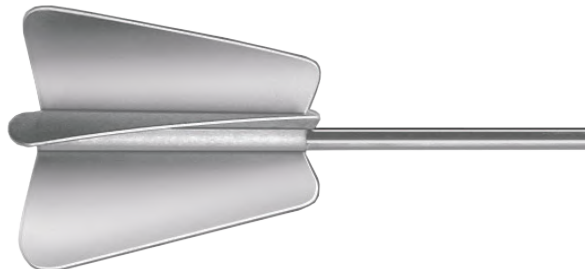

HMA (10042) 5-GALLON HEAVY-DUTY ALUMINUM HELIX MIXER

Brings the fast helix mixing action to thicker compound and mud, in addition to paint and other liquids.



PC1 (10033) 24 OUNCE EZ PAINT CUP

Cup holds 24 ounces of paint and makes painting job faster, neater and easier.

PC2 (10039) 40 OUNCE EZ PAINT PAIL

Pail holds 40 ounces of paint and makes painting faster, neater and easier.

PCL6 (10041) EZ PAINT PAIL LINERS, 6-PACK

Perfect for easy cleanup and quick color changes.



**EASY PAINTING
EASY CLEANUP**



PC12K (19755) 12-PIECE PAINT PROJECT KIT

Includes all the tools necessary for quick and easy paint projects and touch ups.

PCQP (12484) 72-PIECE PAINT PAIL & LINER DISPLAY

18 each: PC2
24 each: PCL6
30 each: PCL1

PAINT PAILS, CUPS & LINERS

- For working on cutouts or small paint jobs
- Nestable design saves space
- Durable construction
- Easy to use & clean
- Rare earth magnets hold brushes in place securely; Angle is adjustable on the PC2
- Liners are designed to fit seamlessly with the EZ Paint Pail or similar paint pails in the market
- Disposable design promotes quick cleanup and easy color changes with little mess



Learn more about our
Paint Pails, Cups & Liners

PAINT MESH STRAINERS

- Perfect for straining all paints & stains
- Removes dried flakes, lumps, filaments and other dust particles from new or old paint
- Fits snugly on 1 or 5 gallons buckets
- Strainers are designed with double stitched edges for durability
- Tight mesh construction
- Elastic top
- Reusable
- Double stitched edges
- Tight nylon mesh



Learn more about our
Paint Mesh Strainers

DOUBLE-STITCHED EDGES FOR DURABILITY



CMS-4PK (41111) 5-3/4" CONE-SHAPED MESH STRAINERS, 4-PACK

Cone-shaped construction prevents spray gun clogging.

ETS1-2PK (41112) 1-GALLON ELASTIC TOP STRAINERS, 2-PACK

Eliminates impurities in new and old paint on 1-gallon buckets.

ETS5-2PK (41113) 5-GALLON ELASTIC TOP STRAINERS, 2-PACK

Eliminates impurities in new and old paint on 5-gallon buckets.

WET BRUSH & ROLLER PROTECTORS

- Eliminates cleaning brushes and rollers during breaks - save paint, water, and time with reusable protectors
- Durable EVA plastic construction with locking system to protect brushes & rollers up to a week
- Fits brushes up to 4" and rollers up to 9.5" for versatile protection
- Can be used with paints, stains, polyurethane & other liquids
- Innovative shape provides wide opening
- Can REUSE multiple times or dispose
- Saves space in toolbox, bag or shelf



Learn more about the Wet Brush & Roller Protectors

PERFECT ADD-ON TO BRUSH & ROLLER SALES



PON-DISP (00012) 48-PIECE PAINT PONCHO DISPLAY
24 each: PON-RL & PON-BR.



PON-BR (00010) REUSABLE WET BRUSH PROTECTOR, 5-PACK
Eliminates the need to clean all brushes up to 4" during breaks.

PON-RL (00011) REUSABLE WET ROLLER PROTECTOR, 5-PACK
Eliminates the need to clean all rollers up to 9.5" during breaks.

PROTECTS FOR AN HOUR, OVERNIGHT, A DAY, A WEEK



ENVIRONMENTAL FOOTPRINT vs. Single Use Plastic Options

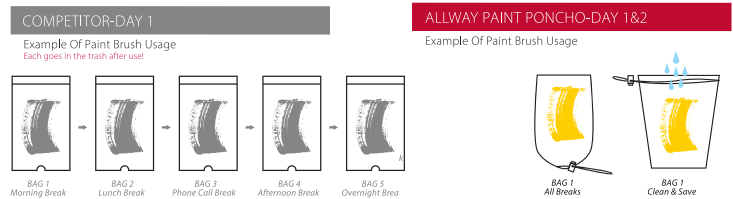



PPO (11350) PLASTIC PAIL OPENER

This lightweight tool helps open paint and stain pails quickly to save time and reduce the risk of injuries.

BSLO (11351) BUCKET SCOOP & LID OPENER

Combination of plastic 5 gallon pail opener and a bucket scoop for viscous material.

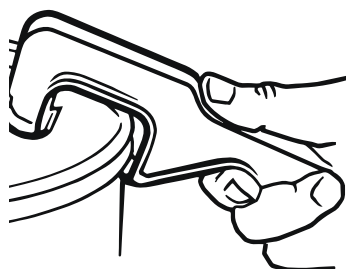

ERGO DESIGN PUTS LESS STRESS ON HANDS

PLASTIC PAIL OPENERS

- High-quality ABS plastic for long-lasting strength.
- Quickly opens lids from 3 to 5 gallon plastic pails
- Saves time and reduces the risk of injuries
- Simply place the “teeth” on the edge of the bucket lid & pry upwards to release seal
- Anti-slip grip and handle length provide leverage for safe handling & easy opening
- Reusable and easy to clean



Learn more about the Plastic Pail Opener

CAN & BUCKET OPENERS



CCL (11028) 2-IN-1 MAGNETIC CAN CLIPS, 16-PACK

CCL15 (11028) 2-IN-1 MAGNETIC CAN CLIPS, 15 PER BUCKET

Quickly and easily opens lids of 3 to 5-gallon lids to save time.

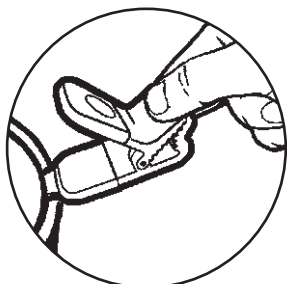

Steel Projection

Pry around the edges to remove the lid.

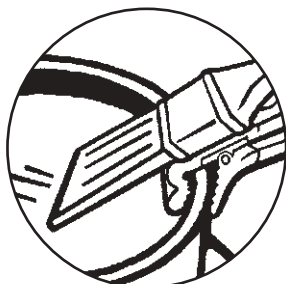

Brush Holder

Two strong magnets hold brush in place when it is not in use.



CBO (11355) CAN & BOTTLE OPENER

Ideal for opening pint, quart, and gallon cans of paint, stain, and varnish.



CBO100 (11356) CAN & BOTTLE OPENERS, 100 PER BUCKET

Rounded opening edge enables damage free opening of the cans lids.

PAINT & TRIM SHIELDS

- Provides a straight edge for clean paint trimming
- Protects molding, ceilings, corners & non-painted surfaces from spillage or over-painting
- Can use in place of painter's tape
- Trim shields include an insert-molded plastic handle
- Paint shields have a stainless-steel blade/edge welded to the handle
- Lightweight construction is easy to grip and comfortable to hold, preventing fatigue
- Holds up to temperature variations
- Will not bend



PS1 (10003) 24" STAINLESS-STEEL EDGE PAINT SHIELD



PS2 (10000) 12" STAINLESS-STEEL EDGE PAINT SHIELD

Provides a straight edge for clean paint trimming to protect molding, ceilings, glass, corners and non-painted surfaces from spatter and over-painting.



TS10 (10013) 10" TRIM SHIELD, 25-PIECE DISPLAY

TS15 (10015) 15" TRIM SHIELD, 25-PIECE DISPLAY

Fits snugly into tight corners, keeping paint splatters off glass, walls, and other surfaces.

TS3PK (41030) 3-PIECE TRIM SHIELD SET

The 6" option is perfect for tight spaces and small, quick jobs. The 10" and 15" options can be used for bigger trim and detailing jobs.

ALUMINUM SPRAY SHIELD

- Protects against unwanted paint-spray splatter.
- Spray quickly without taping
- Innovative clamp design allows easy, on-the-fly adjustment of angle
- Acme-threaded 18" handle included
- Handle snaps onto shield frame
- Patented pole storage system
- Durable aluminum construction



Learn more about the Aluminum Spray Shield

PROTECTS AGAINST PAINT SPLATTER

SS36 (10036) 36" ALUMINUM SPRAY SHIELD

Innovative clamp design allows easy, on-the-fly adjustment of angle.



Pivots to any angle



Handles stores in frame



Handles snaps onto frame



Spray quickly without taping!



- FF (11007) FINE GRIT SANDING SPONGE**
- MF (10007) MEDIUM/FINE GRIT SANDING SPONGE**
- MC (10006) MEDIUM/COARSE GRIT SANDING SPONGE**



- ASB-F (11005) FINE GRIT ANGLED SANDING SPONGE**
- ASB-M (11006) MEDIUM GRIT ANGLED SANDING SPONGE**
- SS100-P (10105) 100-PIECE PREMIUM QUALITY SANDING SPONGES, BOX**
Contains the following: 40 medium/fine, 40 medium/coarse & 20 fine/fine sanding sponges.

SANDING SPONGES

- Great for furniture, wood, paint, metal, kitchen, plastic or drywall.
- Resilient, variegated foam core ensures optimal sanding performance and durability.
- Suitable for wet or dry sanding.
- Simply rinse & reuse.
- Ideal for indoor or outdoor use.
- Flat-edge for sanding flat surfaces with ease.
- Angled edge for sanding contours with ease.
- Flexible & can be cut to smaller pieces.
- Available in a range of grits for a smooth finish.



Learn more about our Sanding Sponges

PAINT POURING SPOUTS

- Makes it easier to pour paint without spillage
- Fits both metal & plastic paint cans
- Works with oil or water-based paints
- Design paint out of can rims



Learn more about our Paint Pouring Spouts



- PEL (10029) 1-GALLON "EASY LID" PAINT POURING SPOUT**
2-piece snap-on can lid with air vent allows for convenient, mess-free paint pouring from 1-gallon cans.



GPS1 (10026) 1-GALLON PAINT POURING SPOUT

Snap-on spout for easy paint pouring from 1-gallon paint cans.

GPS5 (10024) 5-GALLON PAINT POURING SPOUT

Attaches to 5-gallon paint cans for convenient, mess-free paint pouring.

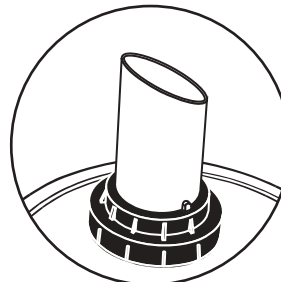

Threaded Pails

Screw directly onto the threaded hole.

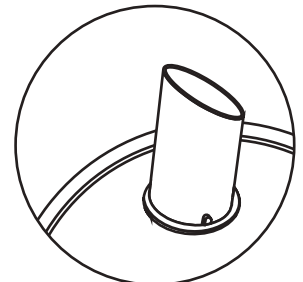

Non-Threaded Pails

Remove ring. Align the 2 locking tabs and push down.

FITS BOTH METAL & PLASTIC PAINT CANS

PAINTER'S TRIPODS

- Designed to elevate items above the work surface for less mess & easier cleanup
- For painting or staining doors, furniture, molding, shutters, pipes, and other bulky items
- Allows one to paint one side, immediately flip it over & continue painting the other side
- Intuitive pin and hole mechanism easily interlocks to support unwieldy items
- Can be screwed down for added stability
- Made of durable Celcon plastic



Learn more about our
Painter's Tripods

FOR PAINTING & STAINING OBJECTS



PT12 (10043) PAINTER'S TRIPODS, 12-PACK

Designed to elevate items above the work surface for less mess and easier cleanup.

LESS MESS & A MUCH EASIER CLEAN-UP



WOOD GRAINING KIT

- 3 piece set that simulates wood grain patterns
- For decorating walls, window frames, beams, doors, desks & more
- Includes 4" quarter round, 2" quarter round, and 3" triangle graining comb
- Special triangle comb gives more control; each side allows you to create various patterns
- Applyt base coat & brush on small area of glaze.
- Drag curved tool through wet surface
- Pivot tool downwards while dragging

GT3 (10023) 3-PIECE WOOD GRAINING SET

3 piece set that simulates natural wood grain patterns.

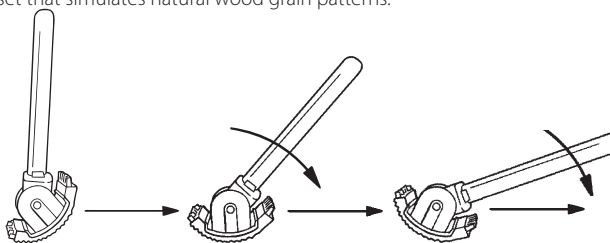

Learn more about our
Wood Graining Tools

LESS CLIMBING UP & DOWN LADDERS

HT-S1 (10055) TELESCOPIC PAINT BUCKET SYSTEM

Height adjustable with a wheeled tripod. This allows for hassle free painting at a height and at ground level.

HT-LR3 (41055) DISPOSABLE BUCKET LINERS, 3-PACK

Disposable paint bucket liners designed to fit into the roller paint bucket.



Disposable Liners

Keeps your paint bucket clean for the next job.



Detachable Tool Tray

Keeps your tools in one place, reducing messy work stations.



Folding Legs

Provide easy storage.



Lockable Wheels

Keeps the Telescopic Bucket System in place.

Quick Release Bucket

Includes an integrated roller slope for easy painting and a magnetic holder for your wet brush.



Height-Adjustable Tripod

Ensures your tools and paint are within easy reach.

TELESCOPIC PAINT BUCKET SYSTEM

- Solid, durable construction
- Height-adjustable, locking tripod
- Facilitates hassle-free painting & wallcovering
- Makes office & house cleaning easier
- Quick release bucket can be detached for filling & low-elevation work
- Magnetic brush attachment stores brush while catching drippage
- Includes detachable tool tray
- Includes two disposable bucket liners
- Essential to meeting OSHA guidelines on ladder safety



Learn more about the Telescopic Paint Bucket System

HASSLE-FREE PAINTING & WALLCOVERING



Painting



Wallcovering



PAINTER'S MULTI-TOOLS



PTG1 (08025) 5-IN-1 PLASTIC PAINTER'S MULTI-TOOL
Serves as a scraper, chisel, crack & can opener, roller cleaner & spackle/adhesive spreader.



TG1 (08008) 5-IN-1 TWO-PIECE STAINLESS-STEEL PAINTER'S MULTI-TOOL
Serves as a scraper, chisel, crack & can opener, roller cleaner & spackle/adhesive spreader.



XG1 (09013) 6-IN-1 NYLON-HANDLE PAINTER'S MULTI-TOOL
Serves as a scraper, chisel, crack & can opener, roller cleaner & spackle/adhesive spreader; die-cast hammer end.



NXG1 (09507) 6-IN-1 ERGONOMIC PAINTER'S MULTI-TOOL
Serves as a scraper, chisel, crack & can opener, roller cleaner & spackle/adhesive spreader; die-cast hammer end.



DSXG16 (09211) 16-IN-1 SOFT-GRIP PAINTER'S MULTI-TOOL
Serves as a spreader, chisel scraper, paint can, bottle & crack opener, roller cleaner, 1/4 & 3/8" nut wrench; heavy-duty hammer end & dual-ended screwdriver bit.



DSXG1 (19196) 6-IN-1 SOFT-GRIP PAINTER'S MULTI-TOOL
Serves as an adhesive spreader, chisel scraper, paint can & crack opener, roller cleaner, nail puller; heavy-duty hammer end.



SXG1 (09196) 8-IN-1 SOFT-GRIP PAINTER'S MULTI-TOOL
Serves as a scraper, chisel, crack & can opener, roller cleaner & spackle/adhesive spreader; screwdriver bit & hammer end.



UXG12 (09407) 12-IN-1 STAINLESS-STEEL PRO PAINTER'S MULTI-TOOL
Serves as a spreader, chisel scraper, crack & can opener, roller cleaner, 1/4 & 3/8" nut wrench, nail puller; built-in hammer end.



SG1 (09016) 5-IN-1 SOFT-GRIP PAINTER'S MULTI-TOOL
Serves as a spreader, chisel scraper, crack & can opener, roller cleaner.



BG1 (09081) EXTENDABLE HEAVY-DUTY 8-IN-1 TOOL, HAMMER END
Serves as a spreader, chisel scraper, crack & can opener, roller cleaner, nail puller; removable hammer end reveals a threaded socket for use with extension pole.

MISCELLANEOUS



BC5 (10112) 5-IN-1 PAINTER'S TOOL
Cleans & rejuvenates paint brushes, can opener, squeegee, standard roller & mini roller cleaner.

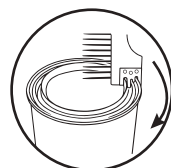

Squeegee

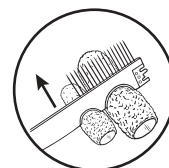

Roller Cleaner



Brush Comb



Lid Opener



BC (10012) BRUSH COMB

Restores your used brushes to their original shape by straightening the filaments; use the comb to clean dried paint and prevent excessive buildup.



BG9HD (17111) 9" BUCKET GRID, 24 PER BOX

Next time you paint with a roller you can skip the step of using and cleaning - a paint tray; this fits 5-gallon buckets.



SW100 (12002) SIDING WEDGES, 100-PACK BAG

Eliminate moisture and peeling paint on exterior walls.



GT (09020) 2-IN-1 GLAZING TOOL

The slotted V-blade allows you to apply a smooth strip of putty, while the scraper and chisel help remove old putty and drive push-style glazing points.



GP1 (12003) GLAZIER'S PUSH POINTS, 50-PACK

Designed to secure glass in frames with precision and ease before applying putty or glazing compound.



GC (10009) CARBIDE GLASS CUTTER

Makes cutting through glass simple and easy.



CP3 (11301) HEAVY-DUTY FLAT CARPENTER'S PENCILS, 3-PACK

Great for marking saw lines, drill pits and much more; Can be used to mark on lumber, paper, concrete and various other materials.



PB1 (10004) 9-1/2" PRY BAR

Used to remove moulding and tiles, open cracks and boxes, scrape paint, pull nails and for other light-to-medium duty jobs.



SPH (10050) SWIVEL PAIL HOOK

Features a curved, pointed end that hooks to a ladder and swivels for convenience; the sturdy clip at the other end attaches to the handle of a paint can and holds it securely.



PH (10011) PAIL HOOK, 2-PACK

Holds 1 or 5-gallon paint cans securely on all types of ladders; also opens paint cans.



MARK (11305) 2 FELT-TIP MARKERS WITH 9MM SNAP-OFF KNIFE

These non-toxic permanent markers are designed with a large tip for easy use; the retractable box cutter is easy to carry and may be used as a scraper.



EBH (11090) EXTENSION BRUSH HOLDER

Accommodates various paintbrush and tool handle shapes, securely gripping them at the desired angle to ensure confident and stable usage.



KP2 (11020) WORK KNEE PADS WITH CUSHION, PAIR

Hard plastic caps on the outside for protection from rough floors and soft, cushiony pads on the inside for comfort.



IPS (10900) PROFESSIONAL SCRATCH AWL & ICE PICK

Ideal for temporary marking and hole piercing on various materials like wood, drywall, and leather; can be used as an industrial ice pick for ice sculpture (not food-grade).



KDS7 (41060) 7-1/2" KNOCKDOWN TEXTURE KNIFE

Engineered for simplicity, this tool features a soft foam edge that effortlessly crafts a stunning knockdown finish.



TS48-C (41056) 48" COLLAPSIBLE T-SQUARE

Adjustable to angles of 30°, 45°, 60°, and 75°, this T-Square offers versatility to meet various project needs.



PSK (05019) PLASTIC SHEET CUTTER

Fast & efficient way to scribe and snap plastic sheets.

CUTS ON REVERSE & FORWARD STROKES

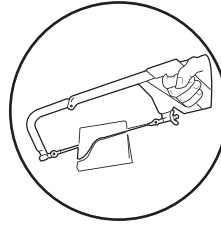

Ceramic Tile, Marble,
Brick & Fiberglass

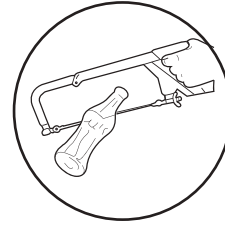

Glass, Plastics,
Cast Iron & Concrete

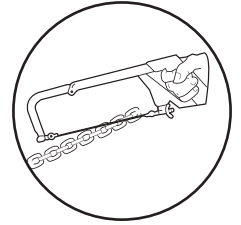

Steel, Clay,
Pipe, Wire
Rope & Slater



RS10 (03050) 10" ROD SAW BLADE

With its tungsten carbide blade, this tool is capable of cutting through glass, tile, marble, brick, cast iron, and more, making it an essential addition to your toolkit.



CH12 (03080) 12" CARBIDE GRIT SAW

With its ability to make thin, straight cuts in ceramic, hardened steel, cast iron, and masonry, this blade is ideal for a wide range of DIY and construction projects



TB12 (11008) 14" NYLON TOOL BAG, 20 POCKETS

Equipped with ten pockets on the inside and an additional ten on the outside, this tool bag offers extensive storage capacity for your tools and accessories.



SB25 (11001) 14" NYLON TOOL BAG, 25 SANDBARS

Ballistic nylon tool bag holds 25 first-quality sandbars (mixed grits).

HANDY SAW

- Pistol-grip keyhole saw with 7-½" blade
- Four optional blade positions
- Blades fasten & lock into place with ease
- Soft-grip handle gives added comfort & reduces hand fatigue during extended projects
- Easily cuts curves, circles & frets into places ordinary saws cannot reach
- HB10T for cutting wood, wallboard, masonite & other fibrous materials
- HB24T for cutting soft metals, nails, metal lath & BX cable
- Blades are compatible with similar saws



Learn more about the Handy Saw.

CUTS WHERE OTHER HACKSAWS CAN NOT

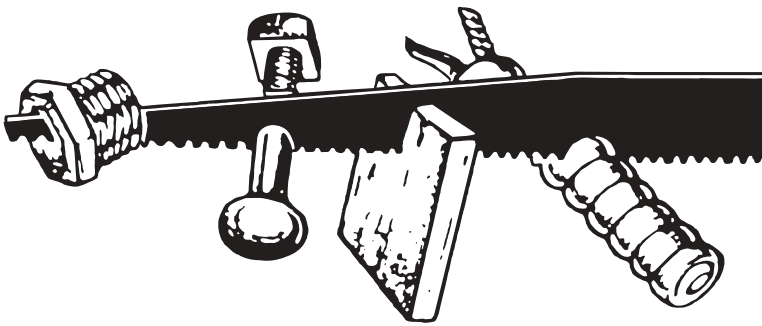

For factories.



For personal garages.

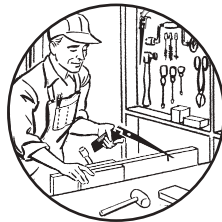

For toolshops.

THE ORIGINAL HANDY SAW

HSN (04001) HANDY SAW NEST, SPARE BLADE

Ideal for cutting drywall, wallboard, plywood, cement board, thin paneling, lumber, PVC, conduit, wires, cables, etc; blades fasten automatically & four adjustable positions.

HBA (04003) HANDY BLADE ASSORTMENT, 2-PACK

Replacement blade set for the Allway Handy Saw and other similar keyhole saws.

HB10T (04006) 10 TPI WOOD CUTTING REPLACEMENT BLADE

Ideal for cutting curves, circles & frets in wood, wallboard, masonite & other fibrous materials.

HB24T (04008) 24 TPI METAL CUTTING REPLACEMENT BLADE

Ideal for cutting soft metals, nails, metal lath & BX cable.

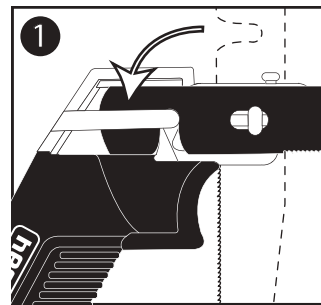

DOWNWARD CUTTING POSITION

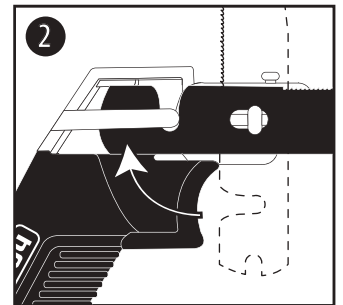

UPWARD CUTTING POSITION

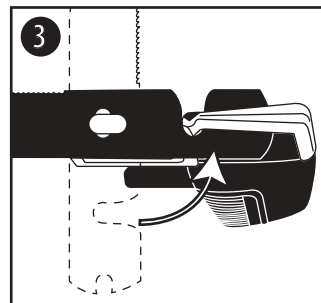

RIGHT CUTTING POSITION

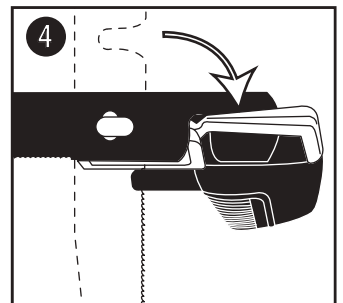

LEFT CUTTING POSITION

COMES WITH FOUR SCREWDRIVER BITS

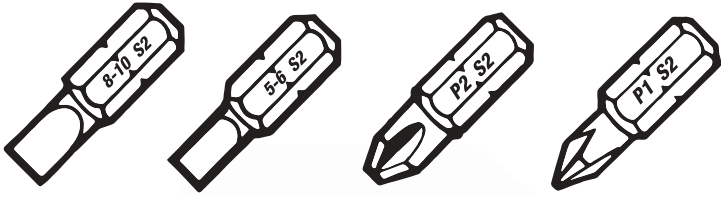

SD41 (18041) 5-IN-1 SAFETY SCREWDRIVER

The patented screwdriver is UL tested and electrically safe to 2,000 volts; it can be used for changing outlet covers, light switches, wiring and other projects.

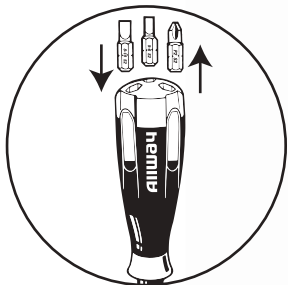

Visible Bit Storage

4 separate bits- all retained in the handle that easily slide in and out to change function.

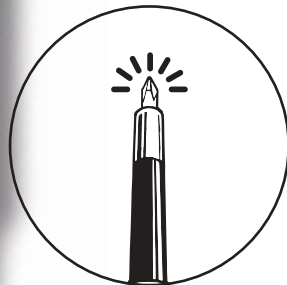

UL Tested to 2000V

This screwdriver is a reliable choice for changing outlet covers, light switches, wiring and more.

5-IN-1 SAFETY SCREWDRIVER

- High-torque, non-slip ergonomic grip with visible bit storage
- Rare earth magnets lock bits securely in place for smoother, more controlled fastening
- Comes with 2 Phillips & 2 slotted power bits, stored in handle for quick access
- Can drive hexagon screws or nuts
- Lightweight, fiberglass-reinforced body for maximum durability
- UL tested - electrically safe up to 2000 volts
- Ideal for electrical work changing outlet covers, light switches, wiring & other jobs



Learn more about the 5-in-1 Safety Screwdriver.

THE IDEAL SCREWDRIVER FOR ANY TOOLBOX



WALLCOVERING TOOLS



VVK (14020) 7-PIECE VINYL WALLCOVERING KIT

Contains soft-grip paste brush, vinyl smoother, snap-off knife, seam roller & plumb bob kit.

PWK (14010) 7-PIECE WALLCOVERING KIT

Contains paste brush, wallpaper smoother brush, snap-off knife, seam roller & plumb bob kit.



RPS3 (14059) PLASTIC SPREADERS, 3-PACK

Versatile spreaders for application of fiberglass filler, caulk, glaze, spackle & putty.



WS (10020) SOFT-GRIP STAINLESS-STEEL WALLPAPER SHEARS

Ideal for for cutting all types of wallcoverings, fabrics, upholstery, vinyl and packaging.



WRP (07231) WALLPAPER PERFORATING TOOL

Scoring and punching tool speeds up wallpaper removal, making the process quick and hassle-free.



STW (07230) SCORING TOOL FOR WALLPAPER REMOVAL

Designed to remove wallpaper from bedrooms, living rooms, and any other living spaces in record time.



RKW2 (10019) RAZOR WALLPAPER KNIFE

For cutting & trimming all wallcovering.



SR2 (10017) HEAVY-DUTY HARDWOOD SEAM ROLLER

Perfectly flattens wallpaper seams, corners, and edges while eliminating air bubbles for a flawless finish.



WT (10110) WALLCOVERING TOOL

Can smooth your wallcovering while its hanging; eliminate air bubbles or use the angled edges for corners.



SST (10040) 5-WAY WALLCOVERING SPREADER & SMOOTHER

Ideal for flawless finishes and a must-have addition to your toolkit. It effortlessly smooths out air bubbles and creases on wallpaper, vinyl wrap, car light tints, etc.

SMOOTH EDGE - NO NOTCHES



STS (15110) 10" x 4-1/4" SMOOTH-EDGE TROWEL

Ideal for applying thin layers of compounds like adhesives, leveling materials, or coatings, ensuring a uniform finish.

V-NOTCHES



SNTV2 (15120) 7/32" x 5/32" V-NOTCHED TROWEL

Ideal for medium-sized tiles or materials where a balance of coverage and adhesive thickness is essential.



SNTV3 (15025) 1/4" x 1/4" x 3/4" V-NOTCHED TROWEL

Ideal for precision adhesive application, particularly in tasks involving wall and ceiling installations

U-NOTCHES



SNTU1 (15122) 1/16" x 1/32" x 1/32" U-NOTCHED TROWEL

Ideal for precise adhesive application in smaller-scale projects.

SNTU2 (15123) 3/32" x 3/32" x 1/8" U-NOTCHED TROWEL

Ideal for spreading adhesive in applications that require a moderate coverage layer.



SQUARE-NOTCHES

SNTS1 (15124) 1/16" x 1/16" x 1/16" SQUARE-NOTCHED TROWEL

Ideal for applying thin layers of adhesive or mortar for small tiles and intricate installations.

SNTS2 (15125) 5/16" x 5/16" x 1/4" SQUARE-NOTCHED TROWEL

Ideal for spreading a thicker layer of adhesive or mortar, making it ideal for larger tiles and heavy-duty applications.



SNTUS (15135) 5/16" x 5/16" x 1/4" SOFT-GRIP COMBO NOTCH TROWEL
Features dual square and U-notches, making it ideal for spreading adhesive and cement.

SOFT-GRIP TROWELS & FLOATS

- Designed for spreading adhesive on various surfaces, including floors, walls & ceilings
- A range of notch shapes tailored to specific needs
- Square-notches deliver maximum adhesive coverage, ideal for flooring coverage
- V-notches provide precision & control, perfect for walls or ceilings
- U-notches ensure balanced, even distribution, a versatile choice for medium-sized tiles & general applications



Learn more about our
Soft-Grip Trowels & Floats

THICKER BASE THAN A TROWEL



SSF (15077) 4" x 9" SOFT-GRIP SPONGE FLOAT

Ideal for texture finishing applications, particularly in smoothing and finishing grout, cement, or other surface materials.

SMOOTHES OUT FLOORS, WALLS & CEILINGS

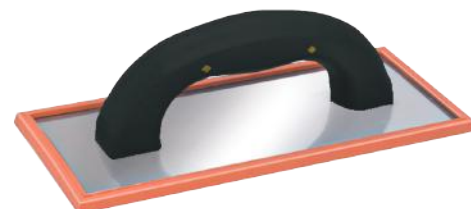

SGF (15170) 4-1/2" x 10" SOFT-GRIP GROUT FLOAT

Ideal for applying and spreading grout over tiled surfaces.



BMTS (14036) 4-1/2" HEAVY-DUTY MASONRY BRUSH

A practical and economical solution to handle both interior and exterior painting jobs or cleaning projects.

BMT (14035) 6-1/2" HEAVY-DUTY MASONRY BRUSH

Ideal for cement, concrete, and masonry, as well as work on sealants and waterproofing materials, this brush is a tool you'll use time and again.

BMTN (1403?) 4-1/2" HEAVY-DUTY DUAL-ENDED MASONRY BRUSH

One end for precise detailing and the other for tackling larger surfaces, making it the perfect all-in-one tool for masonry projects.

WALLPAPER BRUSHES & SMOOTHERS

- Evenly applies wallpaper while eliminating bubbles & wrinkles.
- Ensure a smooth, professional finish every time.



PWB (14030) 6" SOFT-GRIP PASTE BRUSH

Designed for wallcovering and border adhesive spreading, this versatile brush effortlessly dips into paste buckets, making it an ideal choice for pros & DIYers.

SWB (14040) 12" SOFT-GRIP WALLPAPER SMOOTHER

Boasting wide, polypropylene bristles, this brush covers ample surface area, enabling swift and effortless crease-smoothing.

VWB (14050) 12" SOFT-GRIP VINYL SMOOTHER

Designed for wallcovering perfection, it's equally adept for faux finishing endeavors, requiring only light pressure for remarkable outcomes.

MASONRY BRUSHES

- Delivers exceptional performance for cement, concrete & masonry work
- Soft-grip handle ensures a secure hold & comfort
- Heavy-duty structural foam handle provides unmatched strength
- Natural tampico bristles ideal for scrubbing & washing applications
- Excel at scrubbing, washing & the application of sealants or waterproofing materials



Learn more about our
Masonry Brushes

GLUE BRUSHES

- Ideal for woodworking, crafts & repairs.
- Ensure even spreading & accurate placement of glue on a variety of different surfaces.
- For various interior and exterior home tasks.
- Simply clean them with water without the need for additional tools.
- Small enough to fit into tight mortises, yet large enough to spread glue quickly.



TGB (12300) TIN-HANDLE GLUE BRUSH, 5-PACK

Boasts natural horse-hair bristles that excel in precision application for tasks ranging from woodworking and arts & crafts to epoxy resin projects.

SCRUB BRUSHES

- Handy for making cleaning homes, offices, warehouses easier, faster & more efficient.
- Comfortable soft-grip handles.
- Stiff, crimped polypropylene bristles.
- Power through grime effortlessly
- Most models (excluding SBR & SBR2) are threaded for use with a mop stick or extension handle, making hard-to reach areas accessible.
- Compatible with common cleaning chemicals.
- The go-to choice for professionals & DIYers alike.



Learn more about our
Scrub Brushes

IDEAL FOR BOTH RESIDENTIAL & COMMERCIAL PROJECTS



SBA7 (48007) 36-PIECE SCRUB BRUSH ASSORTMENT

6 each: SBR, SBR2, SBR4, SB6, SSB & DB12
6 each: 8" grid wall peg hooks
1 each: universal merchandising rack

**MAKE CLEANING EASIER,
FASTER & MORE EFFICIENT**



SBR (12140) SOFT-GRIP SCRUB BRUSH

Its unique construction allows for effective cleaning while keeping hands away from messes, making it suitable for general cleaning tasks at home or work.

SBR2 (12142) SMALL SOFT-GRIP SCRUB BRUSH

Comfortable, soft-grip cantilever handle allows you to scrub various surfaces with minimal hand fatigue.



SBR4 (12144) SOFT-GRIP LONG-HANDLE SCRUB BRUSH

Crimped, polypropylene and nylon bristles, outer layer of nylon bristles for longer durability & stronger cleaning power; threaded to accept an extension pole.



SBR6 (12813) HEAVY-DUTY SCRUB BRUSH

Comfortable, soft-grip handle allows you to scrub various surfaces with minimal hand fatigue; threaded to accept an extension pole.



SSB (12135) 8" SWIVEL SCRUB BRUSH

The swivel design lets the brush head pivot and adjust to different angles, making it easier to clean corners, edges, and tight spaces without straining or repositioning.



DB12 (12812) 12" HEAVY-DUTY DECK BRUSH

Ideal for not only cleaning or preparing decks for staining, but also for scrubbing walls, kitchen floors, bathroom tub and tile, garages, and more.

“MASTER PRO” PAINT BRUSHES

- Use with all paints, stains & varnish
- Great for interior & exterior paint projects
- Polyester bristles hold an ample amount of paint & provide a smoother stroke
- Straight-edge brushes apply paint over sidings or any other large flat surface
- Angular-edge brushes make it easier to reach corners or where walls meet ceilings
- Re-usable & easy to clean
- Simply remove excess paint with a brush comb, rinse thoroughly & dry upright



Learn more about our
Paint Brushes



A3PK (13815) 3-PIECE ERGONOMIC-STYLE PAINT BRUSH SET
1" angular, 2-1/2" angular & 2" straight-edge brush; unique aluminum construction.



CP6 (12802) 6-PIECE PREMIUM BRUSH SET
Includes 4 flat brushes (MP20, MP15, MP10, MP25); 2 angled brushes (MPS20, MPS25).
MP3PK (13812) 3-PIECE MASTER-PRO BRUSH SET
Set includes: MP20, MPS15, MPS20.

THE PERFECT BRUSHES FOR PROS

STRAIGHT EDGE BRUSHES



MP10 (12803) 1" STRAIGHT-EDGE PAINT BRUSH
MP15 (12804) 1-1/2" STRAIGHT-EDGE PAINT BRUSH
MP20 (12805) 2" STRAIGHT-EDGE PAINT BRUSH
MP25 (12806) 2-1/2" STRAIGHT-EDGE PAINT BRUSH
MP30 (12807) 3" STRAIGHT-EDGE PAINT BRUSH
MP40 (12808) 4" STRAIGHT-EDGE PAINT BRUSH

ANGULAR EDGE BRUSHES



MPS15 (12809) 1-1/2" ANGULAR-EDGE BRUSH
MPS20 (12810) 2" ANGULAR-EDGE BRUSH
MPS25 (12811) 2-1/2" ANGULAR-EDGE BRUSH

ATTACH! EXTEND!! CLEAN!!!



GGB (41063) 10" GUTTER GUARD BRUSH

A versatile addition to your outdoor cleaning arsenal, offering efficient and effective solutions for a variety of tasks.

IDEAL COMPANION FOR GUTTER GUARD MAINTENANCE



Back Diagonal Bristles

Perfect for sweeping away debris from rooftops or other surfaces.



Side Diagonal Bristles

Much easier to clean hard-to-reach areas.

YOUR GUTTER GUARDS & GUTTERS WILL PERFORM LIKE BRAND NEW



Use as Deck Brush

Attach an extension pole & now you can scrub decks & other flat surfaces.

GUTTER GUARD BRUSH

- A great addition to your arsenal of outdoor cleaning tools
- Stiff nylon bristles on three side.
- Effortlessly clears away leaves, pines, needles & other small debris
- Keeps homeowners on the ground & off the ladder
- Attach to an extension pole on either side
- Long enough for 6" gutter guard.
- Can be utilized as a scrub brush



Learn more about our Gutter Guard Brush

STRIPPING BRUSH SET

- Easily detachable brush head
- Nylon brush head designed for paint or corrosion removal & delicate surface cleaning
- Brass brush head designed for the removal of paint & corrosion or moderate metal burnishing
- Stainless-steel brush head designed for aggressive cleaning ladder
- For small-to-moderate jobs & tight spaces



SB3PK (41038) 3-PIECE STRIPPING BRUSH SET

A versatile solution for paint, rust, and scale removal with its easily detachable brush heads.

SOFT-GRIP MINI BRUSHES

- Soft-grip, offset handle protect hand during use
- Solvent & chemical-resistant handles
- Designed to withstand heavy use, ensuring it stays effective for your cleaning & detailing jobs
- Nylon bristles for finishing & light duty paint & rust removal
- Non-sparking brass bristles for metal burnishing & removing paint, rust & scale
- Stainless-steel bristles for aggressive actions to remove paint, rust or scale

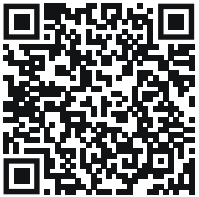

Learn more about our
Soft-Grip Mini Brushes

FOR SMALL JOBS AND TIGHT SPACES



Nylon
Ideal for delicate parts

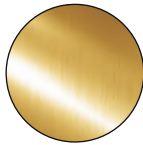

Brass
Ideal for burnishing

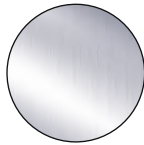

Stainless Steel
Ideal for aggressive cleaning



OFFSET BRUSH HEAD
PREVENT DAMAGE & KEEPS
KNUCKLES SAFE DURING USE



AMB (13710) SOFT-GRIP MINI BRUSH SET, 3-PACK

Ideal for applications like metal burnishing and removal of paint, scale, and rust; extra tufts of bristles at the tip allow you to clean tiny areas easily.

BMB3 (13715) SOFT-GRIP MINI BRASS BRUSH SET, 3-PACK

Ideal for metal burnishing and to remove paint, rust, and scale.

SMB3 (13717) SOFT-GRIP MINI STAINLESS-STEEL BRUSH SET, 3-PACK

Ideal for aggressive actions to remove paint, rust, and scale

NMB3 (13719) SOFT-GRIP MINI NYLON BRUSH SET, 3-PACK

Ideal for finishing and light duty paint and rust removal

HANDLES ARE ANGULAR FOR AN OPTIMUM GRIP



NMB (13712) SOFT-GRIP MINI NYLON BRUSH SET, 25 PER BUCKET

Ideal for finishing and light duty paint and rust removal.

BMB (13714) SOFT-GRIP MINI BRASS BRUSH SET, 25 PER BUCKET

Ideal for metal burnishing and to remove paint, rust, and scale.

SMB (13716) SOFT-GRIP MINI STAINLESS-STEEL BRUSH SET, 25 PER BUCKET

Ideal for aggressive actions to remove paint, rust, and scale.



GB (12125) SOFT-GRIP NARROW NYLON STRIPPER BRUSH

Ideal for finishing and light duty paint and rust removal in tight areas.

BB1 (12126) SOFT-GRIP NARROW BRASS STRIPPER BRUSH

Ideal for metal burnishing and to remove paint, rust, and scale in tight areas.

SB1 (12127) SOFT-GRIP NARROW STAINLESS-STEEL STRIPPER BRUSH

Ideal for aggressive actions to remove paint, rust, and scale in tight areas.



PBS (12128) SOFT-GRIP WIDE NYLON STRIPPER BRUSH

Ideal for finishing and light duty paint and rust removal in tight areas.



BB2 (12129) SOFT-GRIP WIDE BRASS STRIPPER BRUSH

Ideal for metal burnishing and to remove paint, rust, and scale in wide areas.



SB2 (12130) 10" GUTTER GUARD BRUSH

Ideal for aggressive actions to remove paint, rust, and scale in wide areas.

SOFT-GRIP SMALL BRUSHES

- Ergonomic soft-grip offset handle protects hand during use
- Crimped bristles ensure even coverage
- Nylon, stainless or brass bristle.
- Excellent performance on tile, grout, bathrooms & other applications
- GB, BB1 & SB1 feature a narrow head design that fits into tight spaces
- PBS, BB2 & SB2 feature a plastic scraper end to facilitate easy cleaning of residue



Learn more about our Soft-Grip Small Brushes

IDEAL FOR REMOVING PAINT, RUST & SCALE



BM6 (12124) 60-PIECE STRIPPING BRUSH MERCHANDISER

10 each: GB, BB1, SB1, PBS, BB2 & SB2

12 each: 8" grid wall peg hooks

1 each: universal merchandising rack

SOFT-GRIP LARGE WIRE BRUSHES

- Removes paint, rust & scale
- Features tufts of carbon steel, stainless steel or brass wire bristles
- Ergonomic offset handle design to protect hand during use
- Soft grip for comfort
- Chemical & solvent resistant
- Strong structural foam construction
- Hardened ground steel scraper ends on certain models (SB319, SB319/SS, SB319/BB, SB411)



Learn more about our Soft-Grip Large Wire Brushes

IDEAL FOR REMOVING PAINT, RUST & SCALE



SB4D (12324) 48-PIECE WIRE BRUSH MERCHANDISER

12 each: SB319, SB411, SB416, SB619
8 each: 8" grid wall peg hooks
1 each: universal merchandising rack

FOR HEAVY DUTY SCRAPING ACTION



SB319 (12319) SOFT-GRIP CARBON-STEEL WIRE BRUSH, 3 x 19 ROWS
3 x 19 rows of carbon-steel bristles; heavy-duty scraper end.



SB319/SS (12219) SOFT-GRIP STAINLESS-STEEL WIRE BRUSH, 3 x 19 ROWS
3 x 19 rows of stainless-steel bristles; heavy-duty scraper end.



SB319/BB (12229) SOFT-GRIP BRASS WIRE BRUSH, 3 x 19 ROWS
3 x 19 rows of brass bristles; heavy-duty scraper end.



SB411 (12411) SOFT-GRIP CARBON-STEEL WIRE BRUSH, 4 x 11 ROWS
4 x 11 rows of carbon-steel bristles; heavy-duty scraper end.



SB416 (12416) SOFT-GRIP CARBON-STEEL WIRE BRUSH, 4 x 16 ROWS
4 x 16 rows of carbon-steel bristles; no heavy-duty scraper end.



SB619 (12619) SOFT-GRIP CARBON-STEEL BLOCK BRUSH, 6 x 19 ROWS
6 x 19 rows of carbon-steel bristles; threaded hole for extension pole.



SB619/SS (12629) SOFT-GRIP STAINLESS-STEEL BLOCK BRUSH, 6 x 19 ROWS
6 x 19 rows of stainless-steel bristles; threaded hole for extension pole.

3 X 19 ROWS OF BRISTLES



WBS319 (21319) LONG WOOD-HANDLE WIRE BRUSH, 3 X 19 ROWS

3 x 19 rows of carbon-steel bristles; heavy-duty scraper end.

WB319/SS (20319) LONG-HANDLE-WIRE BRUSH, 3 X 19 ROWS

3 x 19 rows of stainless-steel bristles; no heavy-duty scraper end.

WBC319 (22319) LONG-HANDLE-WIRE BRUSH, 3 X 19 ROWS

3 x 19 rows of carbon-steel bristles; no heavy-duty scraper end.

4 X 11 ROWS OF BRISTLES



WBS411 (21411) WOOD-HANDLE WIRE BRUSH, 4 X 11 ROWS

4 x 11 rows of carbon-steel bristles; heavy-duty scraper end.

6 X 19 ROWS OF BRISTLES



WB619 (22619) WOOD-HANDLE BLOCK BRUSH, 6 X 19 ROWS

6 x 19 rows of carbon-steel bristles; heavy-duty scraper end.

4 X 16 ROWS OF BRISTLES



WBS416 (21416) WOOD-HANDLE WIRE BRUSH, 4 X 16 ROWS

4 x 16 rows of carbon-steel bristles; heavy-duty scraper end.

WB416/SS (20416) WOOD-HANDLE WIRE BRUSH, 4 X 16 ROWS

4 x 16 rows of stainless-steel bristles; no heavy-duty scraper end.

WB416 (22416) WOOD-HANDLE WIRE BRUSH, 4 X 16 ROWS

4 x 16 rows of carbon-steel bristles; no heavy-duty scraper end.

WOOD-HANDLE WIRE & WELDING BRUSHES

- Made for tough cleaning & welding jobs
- Scrapes off rust, paint & grime
- Wood handle gives you a solid grip
- Great for metal surfaces, machines & hard-to-reach spots



Learn more about our
**Wood-Handle Wire & Welding
Brushes**

3 X 7 ROWS OF BRISTLES



UWB37-2SS (41156) WOOD-HANDLE STAINLESS WIRE BRUSH, 3 X 7 ROWS

Ideal for general cleaning, delicate or finish work and hard-to-reach welding jobs.

UWB37-2BR (41158) WOOD-HANDLE BRASS WIRE BRUSH, 3 X 7 ROWS

Provides light duty cleaning of hard-to-reach areas and for cleaning welds.

2 X 9 ROWS OF BRISTLES



UWB29-2SS (41157) WOOD-HANDLE STAINLESS WIRE BRUSH, 2 X 9 ROWS

A medium brush for general-purpose cleaning; also good for delicate or finish work and can be used to clean aluminum.

UWB29-2BR (41159) WOOD-HANDLE BRASS WIRE BRUSH, 2 X 9 ROWS

For general-purpose cleaning & welding projects, including delicate or finish work.



GA-GP (41141) 8-1/4" BY-PASS ALUMINUM GARDEN PRUNER

Ideal for pruning green, living growth like ornamental shrubs and trees with a maximum cut width of 3/4 inch.



GA-SNP (41142) 6-3/4" SOFT-GRIP GARDEN SNIP

Pruning tasks like cutting flower stems or maintaining your herb garden are easier with fast and clean cuts.



GA-PRU-2PK (41143) 2-PIECE PRUNER SET

Set includes a mini bypass trimmer & floral shears.

**3-STAGE RATCHET ACTION
MAKES IT EASY ON THE HANDS**



GA-RBP41 (41144) 4-IN-1 RATCHET BYPASS PRUNER

Clean up flower beds and garden rows. Cut tree branches up to 1" thick, depending on the wood and your individual strength.

**TELESCOPIC HANDLE WILL GIVE YOU
A GREATER REACH AS WELL AS
MAKE CUTS EASIER STILL**



GA-XRTL (41145) EXTENDABLE JUMBO RATCHET TREE LOPPER

They cut through thicker branches than pruners and hedge shears and require two hands to operate.

PRUNERS, SNIPS & SHEARS

- Designed for clean, precise cuts to promote healthy plant growth
- Helps reduce hand fatigue for more comfortable, extended use
- Built for a variety of trimming, shaping & pruning tasks
- Great for both indoor and outdoor gardening applications
- Ideal for all gardeners from DIYer to pros
- Offers improved control and accuracy when working in tight spaces

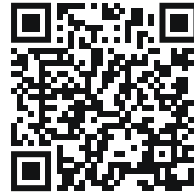

Learn more about our
Pruners, Snips & Shears

**ERGONOMIC ANTI-SLIP HANDLE
PROVIDES A COMFORTABLE GRIP
DURING USE**



GA-XHS (41146) EXTENDABLE HEDGE SHEARS

Perfect for trimming and shaping hedges, decorative shrubs.

**IDEAL FOR PRUNING LIVE GROWTH,
STEMS & LIGHT BRANCHES**

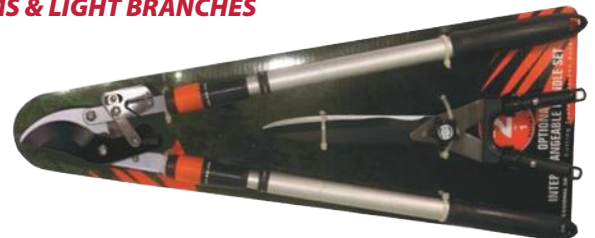

GA-LHS-2PK (41147) 2-PIECE LOPPER SET

Set includes a 2-in-1 ratchet lopper & hedge shears.

STORE MERCHANDISERS



BM6 (12124) 60-PIECE STRIPPING BRUSH MERCHANDISER

10 each: GB, BB1, SB1, PBS, BB2 & SB2
12 each: 8" grid wall peg hooks
1 each: universal merchandising rack



SB4D (12324) 48-PIECE WIRE BRUSH MERCHANDISER

12 each: SB319, SB411, SB416, SB619
8 each: 8" grid wall peg hooks
1 each: universal merchandising rack



FB7 (06004) 50-PIECE TUBULAR WOOD SCRAPER MERCHANDISER

5 each: BF1, F42, F22 and F1
10 each: 1B, 22B, 42B
1 each: universal merchandising rack
7 each: 8" grid wall peg hooks



FM7 (06048) 50-PIECE SOFT-GRIP WOOD SCRAPER MERCHANDISER

5 each: F4, FE2, FE1, BF1
10 each: 1B, 22B, 42B
1 each: universal merchandising rack
8 each: 8" grid wall peg hooks



CBSM6 (06570) 30-PIECE SOFT-GRIP CARBIDE SCRAPER MERCHANDISER

5 each: CBS25, CBS20, CBS10, CB25, CB20 & CB10
1 each: universal merchandising rack
6 each: 8" grid wall peg hooks



PW8 (08016) 80-PIECE TWO-PIECE STAINLESS-STEEL JOINT KNIFE MERCHANDISER

10 each: T15F, T15S, TG1, T30F, T30S, T45, T60, T100
8 each: 8" grid wall peg hooks
1 each: universal merchandising rack



XW8 (09014) 40-PIECE NYLON-HANDLE JOINT KNIFE MERCHANDISER
 5 each: X1-1/4F, X1-1/4S, X3F, X3S, X4F, X5F, X6F, XG1
 8 each: 8" grid wall peg hooks
 1 each: universal merchandising rack



NXW7 (09519) 35-PIECE TWO-PIECE STAINLESS-STEEL JOINT KNIFE MERCHANDISER
 5 each: NX15F, NX15S, NX3F, NX3S, NX4F, NX6F & NXG1
 7 each: 8" grid wall peg hooks
 1 each: universal merchandising rack



DSXW11 (19199) 55-PIECE SOFT-GRIP JOINT KNIFE MERCHANDISER
 5 each: DSX15F, DSX15S, DSX2F, DSX2S, DSX3F, DSX3S, DSX4F, DSX5F, DSX6F, DSXCH, DSXG1, DSXG16
 11 each: 8" grid wall peg hooks
 1 each: universal merchandising rack



SKA16 (41036) 96-PIECE SNAP KNIFE ASSORTMENT
 6 each: SK9T, SK9B, KS13, SK18T, SK18BS, SK18BW, SK25T, SK25B, SB9-5B, SB9-5C, SB9-5T, SB18-5B, SB18-5C, SB18-5T, SB25-5B & SB25-5T.
 11 each: 8" grid wall peg hooks
 1 each: universal merchandising rack



SXW8 (09198) 40-PIECE SOFT-GRIP JOINT KNIFE MERCHANDISER
 5 each: SXG1, SX1-1/2F, SX1-1/2S, SX3F, SX3S, SX4F, SX5F, SX6F
 8 each: 8" grid wall peg hooks
 1 each: universal merchandising rack



UXW8 (09419) 40-PIECE UNIBODY STAINLESS-STEEL JOINT KNIFE MERCHANDISER
 5 each: UX15F, UX2F, UX3F, UX4F, UX5F, UX6F, UX8F, UX10F
 8 each: 8" grid wall peg hooks
 1 each: universal merchandising rack



SBA7 (48007) 36-PIECE SCRUB BRUSH ASSORTMENT
 6 each: SBR, SBR2, SBR4, SB6, SSB & DB12
 6 each: 8" grid wall peg hooks
 1 each: universal merchandising rack



DWRA (48009) 66-PIECE DRYWALL REPAIR ASSORTMENT
 10 each: UPS, UHS, DWS & DSS
 4 each: DW5PK
 6 each: HMA
 5 each: BTK8, BTK10 & BTK12
 1 each: SS100
 8 each: 8" grid wall peg hooks
 1 each: universal merchandising rack



HLX34 (41084) 34-PIECE HELIX

MIXER ASSORTMENT

- 10 each: HM1
- 6 each: HM5, HM5N, HMA, HMQ
- 5 each: 8" grid wall peg hooks
- 1 each: universal merchandising rack

BR1 (82250) BUCKET RING - HOLDS 1 BUCKET

Carbon-steel bucket ring is to be used in store to display bucket items in pegboard.



For more information on our Bucket Tree Program, flip to page 68

BTM (19221) 12-PIECE BUCKET TREE MERCHANDISER

- 1 each: K13-50, CBO100, SEB10-50, TG1-25, MK3-50, GS50, SGS25, DS20, CCL15, DS40, GSM100, K7-25
- 1 each: BTM12
- 12 each: BR1

BTM12 (81915) BUCKET TREE (SANS MERCHANDISER)

Designed to hold 12 buckets and comes free with orders of 12 or more buckets



Please note that the above picture is for reference only.

ASMT2 (48002) 450-PIECE ALLWAY® 2' STARTER ASSORTMENT

- 5 each: UX5F, UX4F, UX3F, UX2F, UX15F, UHS, X4F, X3S, X3F, X2S, X2F, X1-1/4S, X1-1/4F, XCH1-1/4, UPS, CT31, WPS & FE1
- 6 each: DSXG16, HM5N, SB19, SB416, WEK2 & WEP2
- 10 each: T60, T30S, T30F, T15S, T15F, SD41, HM1, F4, GS, SPH, PB1, GSM, RK4, KS7, KS13, RKB5, K7B, SNB, WSB, 42B, 1B, SEB100VP, SB2, BB2, PB2, FF, MC, MF, WP6 & WP4
- 12 each: DS-3PKL & AMB
- 56 each: 8" grid wall peg hooks



Please note that the above picture is for reference only.

ASMT4 (48004) 719-PIECE ALLWAY® 4' STARTER ASSORTMENT

- 5 each: UX10F, UX8F, UX5F, UX4F, UX3F, UX2F, UX15F, X6BIT, X6F, X5F, X4F, X3S, X3F, X2S, X2F, X1-1/2S, X1-1/2F, XCH1-1/4, X1-1/4F, X1-1/4S, X-3/4S, X-3/4F, XG1, FE2, FE1, FS3, BS3, BG1, CT31, UPS, UHS & WPS
- 6 each: DSXG16, HM5, HM5N, CS6, WEP2 & PT10
- 10 each: T100, T60, T45, T30S, T30F, T15S, T15F, TG1, SD41, F4, SGS, GS, SPH, 42B, 22B, 1B, RSK, RK4, RKB5, KS7, KS13, K7B, SNB, SEB10, GSM, WSB, PB1, SB1, SB2, HM1, WP8, WP4, PB1 & PB2
- 12 each: DS-3PKL, SG1, PON-BR, PON-RL & AMB
- 76 each: 8" grid wall peg hooks

PCQP (12484) 72-PIECE PAINT PAIL & LINER DISPLAY

18 each: PC2
24 each: PCL6
30 each: PCL1



PC12K-QP (19756) 36-PIECE QUARTER PALLET, PAINT PROJECT KIT

36 each: PC12K



BS3-DSP (19206) 10-PIECE COUNTER DISPLAY, 3" SOFT-GRIP BENT SCRAPER

CT31-DSP (00012) 10-PIECE COUNTER DISPLAY, 3-IN-1 CAULK TOOL



DSX6F-DSP (19214) 14-PIECE COUNTER DISPLAY, 6" SOFT-GRIP FLEX JOINT KNIFE

DSXG16-DSP (19217) 10-PIECE COUNTER DISPLAY, 16-IN-1 SOFT-GRIP PAINTER'S MULTI-TOOL

STORE DISPLAYS



GSK3-DSP (19210) 12-PIECE COUNTER DISPLAY, GLASS & TILE SCRAPER KIT



HSN-DSP (19210) 12-PIECE COUNTER DISPLAY, HANDY SAW NEST



PHS-DSP (19207) 5-PIECE COUNTER DISPLAY, SOFT-GRIP PALM SANDER



PON-DISP (00012) 48-PIECE PAINT PONCHO DISPLAY 24 each: PON-RL & PON-BR.

MERCHANDISERS & DISPLAYS



RK7-DSP (19205) 17-PIECE COUNTER DISPLAY, 18MM SNAP-OFF KNIFE



SWK-DSP (19213) 14-PIECE COUNTER DISPLAY, SWITCHBACK SAFETY KNIFE



RSK-DSP (19204) 17-PIECE COUNTER DISPLAY, SOFT-GRIP RETRACTABLE UTILITY KNIFE



SX3F-DSP (19208) 14-PIECE COUNTER DISPLAY, 3" FLEX PUTTY KNIFE



SX6F-DSP (19215) 14-PIECE COUNTER DISPLAY, 6" FLEX JOINT KNIFE



SGS-DSP (81915) 11-PIECE COUNTER DISPLAY, SOFT-GRIP SCRAPER



UX6F-DISP (19216) 14-PIECE COUNTER DISPLAY, 6" JOINT KNIFE



UPS-DSP (19211) 10-PIECE COUNTER DISPLAY, POLE SANDER



UHS-DSP (19212) 8-PIECE COUNTER DISPLAY, HAND SANDER



SNP6-DSP (19219) 24-PIECE COUNTER DISPLAY, SMALL HOLE REPAIR KITS



WED20 (13093) 20-PIECE WALL-EZ™ DRYWALL REPAIR COUNTER-DISPLAY



- NMB (13712)** SOFT-GRIP MINI NYLON BRUSH SET, 25 PER BUCKET
- BMB (13714)** SOFT-GRIP MINI BRASS BRUSH SET, 25 PER BUCKET
- SMB (13716)** SOFT-GRIP MINI STAINLESS-STEEL BRUSH SET, 25 PER BUCKET



- CBO100 (11356)** CAN & BUCKET OPENERS, 100 PER BUCKET
- CCL15 (11028)** 2-IN-1 CAN CLIPS, 15 PER BUCKET



- DS15 (08115)** 1-1/2" CELCON PLASTIC PUTTY KNIFE, 25 PER BUCKET
- DS20 (08120)** 2" CELCON PLASTIC PUTTY KNIFE, 25 PER BUCKET
- DS30 (08113)** 3" CELCON PLASTIC WALL SCRAPER, 25 PER BUCKET
- DS30V (08133)** 3" CELCON V-NOTCH SPREADER, 25 PER BUCKET
- DS40 (08140)** 4" CELCON PLASTIC JOINT KNIFE, 25 PER BUCKET
- DS60 (08600)** 6" CELCON PLASTIC TAPE KNIFE, 25 PER BUCKET



- GS50 (07031)** SAFETY GLASS SCRAPERS, 50 PER BUCKET
- SGS25 (07327)** SOFT-GRIP GLASS SCRAPERS, 25 PER BUCKET
- GSM100 (07080)** MINI GLASS SCRAPERS, 100 PER BUCKET

BUCKET TREE PROGRAM



- EK50 (07035)** NEON EASY CUTTERS, 50 PER BUCKET
- MK3-50 (07020)** NEON MICRO KNIVES, 50 PER BUCKET



- K7-25 (07050)** 18MM SNAP-OFF KNIVES, 25 PER BUCKET
- K13-50 (07040)** 9MM SNAP-OFF KNIVES, 50 PER BUCKET
- KC25 (07001)** POLY-PRO PLASTIC UTILITY KNIVES, 25 PER BUCKET
- PRK25 (07100)** PLASTIC RETRACTABLE UTILITY KNIVES, 25 PER BUCKET
- SLK25 (07110)** RETRACTABLE UTILITY KNIVES, 25 PER BUCKET
- TG1-25 (08009)** 10" TWO-PIECE 5-IN-1 TOOLS, 25 PER BUCKET
- SEB10-50 (07095)** 10-PACK BLADE DISPENSERS, 50 PER BUCKET
- SEB100/5 (07090)** 5-PACK BLADE DISPENSERS, 50 PER BUCKET



EMPTY BUCKET TREE RACK HOLDS 12 BUCKETS
included with the purchase of 12 buckets

Terms

Net 30 days. All new accounts will be required to make payment in advance.

F.O.B

Factory, Bronx, N.Y.

Freight Allowance

Freight is fully prepaid on orders of \$1,000 USD net or more, shipped via our routing **within the continental U.S.** For foreign shipments, inland freight on qualifying orders **is prepaid to the port of exit**, including Alaska, Hawaii, Puerto Rico, and western Canada. Customers requesting "notification before delivery" will be charged for the carrier's notification fees.

Minimum Order

\$100 minimum. **Less than the minimum gets a \$10.00 service charge** within the United States.

International orders are \$750.00. **Less than the minimum gets a \$40.00 service charge.**

Shipping Discrepancy

All shipping-related issues, including shortages or damages, must be reported to customer service **within 5 working days of receipt.** Any damages should also be reported directly to the carrier.

Returns

All returns must have an RGA (Return Goods Authorization) number assigned by Allway Tools before being shipped back. This number must be clearly marked and included with the return. Products must be in their original packaging and in **"new" sellable condition.** Merchandise can only be returned in the original pack quantity sold. A 20% restocking fee applies, and customers are responsible for all shipping costs. Refunds will be issued after the returned goods are received, inspected, and verified for condition and quality.

Warranty

Allway products are guaranteed to be free from manufacturing defects. Defective items will be replaced free of charge upon inspection. No additional warranties are expressed or implied.

Prices

Pricing may be adjusted at any time without prior notification.

Please email all orders to cs@allwaytools.com

Allway Tools
1255 Seabury Avenue
Bronx, New York 10462
Telephone: 718-792-3636
Fax: 718-823-9640

BECOME AN ALLWAY PARTNER

Having the right partner is critical for the success of your business. ALLWAY® values a strong relationship with our distributors and puts their needs first. Our team is willing to hear about potential partnerships. We are looking for long-term, trusting, and collaborative partnerships. We truly believe collaborating with those who have local expertise delivers that.



Premium, Value-Added Products

For over 90 years, Allway Tools has created products that add value for both professionals and do-it-yourselfers. Our commitment to quality, durability, and innovation has made us a trusted partner for those who need tools that make their work easier, faster, and more convenient.

By incorporating our products into your offerings, you can expand your business and enhance your reputation. You can be confident that you're selecting a range of products that are renowned for their performance, and that will boost your sales while providing exceptional value to your customers.

Our Customers Come First

We go beyond being a mere supplier - we become invested in the success of your business. With access to our product literature, technical information, case studies, company literature, graphics, and even optional support for exhibitions and events, our distributors gain the tools necessary to make successful sales and cultivate long-lasting customer relationships.

To ensure your success, we not only have an in-house team ready to assist you, but independent sales representatives will listen to your needs and offer guidance and direction. Our team will then customize a program to suit your specific needs.



Excellent Service

Since 1935, our success has been powered by the exceptional people behind Allway Tools. We take the time to understand your unique operations and challenges, no matter the size of your enterprise. By delivering personalized solutions tailored to your needs, we're committed to driving your success and long-term growth.

What sets us apart is our proven in-house product expertise and relentless drive for innovation. We design products that make home improvement projects faster, safer, and less stressful—providing unmatched efficiency and convenience.

Outstanding Supply

Selling in a market dominated by big-box retailers and e-commerce can be challenging—but at Allway Tools, we provide our partners with opportunities to thrive. While we understand the need to stay competitive, our partnership offers far more than just great pricing. With an extensive product selection, reliable availability, and proven sales support, we're here to help you succeed.

Our global supply chain ensures competitive pricing while maintaining efficient inventory levels. From our 80,000-square-foot warehouse, we distribute products to partners worldwide, ensuring timely delivery and consistent supply.





Allway®
Innovation Since 1935

1255 Seabury Avenue, P.O. Box 777, Bronx, New York 10462 USA
Phone: 1-718-792-3636 · Toll-Free: 1-800-422-5592 · Fax: 1-718-823-9640
sales@allwaytools.com · cs@allwaytools.com · allwaytools.com

SKU CATALOG - 04.17.2025

Copyright 2025 — Allway Tools Inc. — All Rights Reserved